

# User's Manual

## Industrial Renewable Energy 4-Port 10/100/1000T 802.3at PoE+ Managed Ethernet Switch

▶ BSP-360



**Trademarks**

Copyright © PLANET Technology Corp. 2017.

Contents are subject to revision without prior notice.

PLANET is a registered trademark of PLANET Technology Corp. All other trademarks belong to their respective owners.

**Disclaimer**

PLANET Technology does not warrant that the hardware will work properly in all environments and applications, and makes no warranty and representation, either implied or expressed, with respect to the quality, performance, merchantability, or fitness for a particular purpose. PLANET has made every effort to ensure that this User's Manual is accurate; PLANET disclaims liability for any inaccuracies or omissions that may have occurred.

Information in this User's Manual is subject to change without notice and does not represent a commitment on the part of PLANET. PLANET assumes no responsibility for any inaccuracies that may be contained in this User's Manual. PLANET makes no commitment to update or keep current the information in this User's Manual, and reserves the right to make improvements to this User's Manual and/or to the products described in this User's Manual, at any time without notice.

If you find information in this manual that is incorrect, misleading, or incomplete, we would appreciate your comments and suggestions.

**FCC Warning**

This equipment has been tested and found to comply with the limits for a Class A digital device, pursuant to Part 15 of the FCC Rules. These limits are designed to provide reasonable protection against harmful interference when the equipment is operated in a commercial environment. This equipment generates, uses, and can radiate radio frequency energy and, if not installed and used in accordance with the Instruction manual, may cause harmful interference to radio communications. Operation of this equipment in a residential area is likely to cause harmful interference in which case the user will be required to correct the interference at his own expense.

**CE Mark Warning**

This is a Class A product. In a domestic environment, this product may cause radio interference, in which case the user may be required to take adequate measures.

**Energy Saving Note of the Device**

This power required device does not support Standby mode operation. For energy saving, please remove the power cable to disconnect the device from the power circuit. In view of saving the energy and reducing the unnecessary power consumption, it is strongly suggested to remove the power connection for the device if this device is not intended to be active.

**WEEE Warning**

To avoid the potential effects on the environment and human health as a result of the presence of hazardous substances in electrical and electronic equipment, end users of electrical and electronic equipment should understand the meaning of the crossed-out wheeled bin symbol.

Do not dispose of WEEE as unsorted municipal waste and have to collect such WEEE separately.

**Revision**

Industrial Renewable Energy 4-Port 10/100/1000T 802.3at PoE+ Managed Ethernet Switch User's Manual

Model: BSP-360

**Revision:** 1.0 (February, 2017)

**Part No.:** EM-BSP-360\_v1.0

---

## TABLE OF CONTENTS

<b>1. INTRODUCTION</b> .....	<b>6</b>
1.1 Package Contents.....	6
1.2 Product Description.....	6
1.3 How to Use This Manual.....	11
1.4 Product Features .....	12
1.5 Product Specifications.....	14
<b>2. INSTALLATION</b> .....	<b>18</b>
2.1 Hardware Description .....	18
2.1.1 Injector Front Panel.....	18
2.1.2 LED Indicators.....	19
2.1.3 Switch Upper Panel.....	20
2.1.4 Wiring the Fault Alarm Contact .....	21
2.1.5 Wiring the Digital Output .....	22
2.2 Installing the Renewable Energy Switch .....	22
2.2.1 Installation Steps.....	23
2.2.2 DIN-rail Mounting .....	28
2.2.3 Wall-mount Plate Mounting .....	30
<b>3. MANAGEMENT</b> .....	<b>32</b>
3.1 Overview .....	32
3.2 Requirements.....	32
3.3 Management Method .....	32
3.3.1 Web Management.....	33
3.3.2 PLANET Smart Discovery Utility .....	34
<b>4. WEB CONFIGURATION</b> .....	<b>37</b>
4.1 Main Menu .....	37
4.2 Web Panel .....	39
4.3 System.....	40
4.3.1 System Information .....	40
4.3.2 Operation Mode.....	44
4.3.3 Time Zone.....	45
4.3.4 User Management.....	46
4.3.5 SNMP.....	47
4.4 TCP/IP .....	49
4.4.1 WAN.....	49
4.4.2 LAN .....	54
4.4.3 Server.....	56

---

4.4.4	Security .....	58
4.4.5	Route.....	63
4.4.6	QoS (Quality of Service).....	65
4.5	Battery Management.....	67
4.6	PoE Management .....	71
4.6.1	PoE Configuration .....	72
4.6.2	PoE Status .....	74
4.6.3	PoE Schedule .....	75
4.6.4	PoE Alive Check Configuration .....	79
4.7	Maintenance .....	81
4.7.1	Ping.....	82
4.7.2	USB Backup.....	83
4.7.3	System Backup/Restore.....	83
4.7.4	Firmware Upgrade.....	84
<b>5.</b>	<b>POWER OVER ETHERNET OVERVIEW .....</b>	<b>85</b>
<b>6.</b>	<b>THE POE PROVISION PROCESS .....</b>	<b>87</b>
6.1	Line Detection.....	87
6.2	Classification.....	88
6.3	Start-up .....	88
6.4	Operation .....	88
6.5	Power Disconnection Scenarios .....	89
<b>APPENDIX A.</b>	<b>.....</b>	<b>90</b>
A.1	MDI Settings .....	90
A.2	Power Device Classification Values.....	90
A.3	DATA OUT PoE Injector RJ45 Port Pin Assignments.....	91
A.4	RJ45 Pin Assignment of Non-802.3af/802.3at Standard PD with PoE Mid-span PD .....	91
<b>APPENDIX B.</b>	<b>.....</b>	<b>92</b>
B.1	Recommended Use of the Connected Wires.....	92
B.2	Recommended Settings for Different Batteries.....	92

# 1. INTRODUCTION

## 1.1 Package Contents

Open the box of the Renewable Energy Switch and carefully unpack it. The box should contain the following items:

- The BSP-360 x 1
- Quick Installation Guide x 1
- Wall Mounting Kit x 1
- DIN Rail Kit x 4
- RJ45 Dust Cap x 2



If any of the above items are missing, please contact your seller immediately.

## 1.2 Product Description

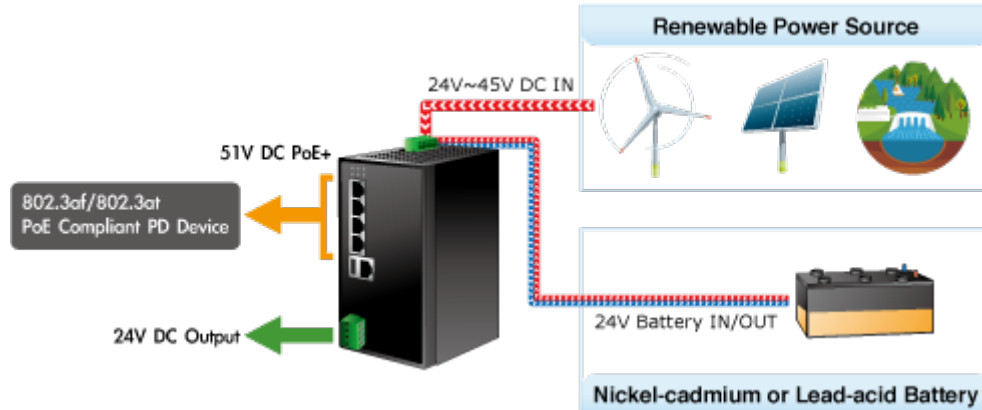
### Industry-leading Integration of PoE Technology and Renewable Power System

PLANET's newly-launched Renewable Energy Industrial 802.3at PoE Managed Ethernet Switch, BSP-360, is designed for deploying a surveillance or wireless network and remotely monitoring and managing the IP-based devices. Based on its green technology, the BSP-360 can be charged by the inexhaustible and natural source of energy, such as solar, wind and hydroelectric power to conserve energy so as to economically power these remote IP cameras and wireless APs, especially used for such expansive applications as dams, forests, deserts, national parks, nature/animal protection areas and highways.



## Zero-Carbon and Stable Power Supply

The BSP-360 utilizes the solar power sourcing and co-works with the common **nickel-cadmium battery** or **lead-acid battery** to form an independent solar power supply system for outdoor network system. The BSP-360 delivers zero-carbon and uninterruptible PoE power supply for continuous outdoor wireless and IP surveillance applications without the need of any cabling. It can power the client devices and can be charged at the same time during the day to enable to continue the operation at night.



## Built-in Unique Power Functions for Battery Management

As it is the power managed for battery and power consumption, the BSP-360 features the following special power management functions:

- Battery current usage and status
- Battery capacity statistics
- Low voltage cut-off protection

### Battery Current Usage Status and Statistics

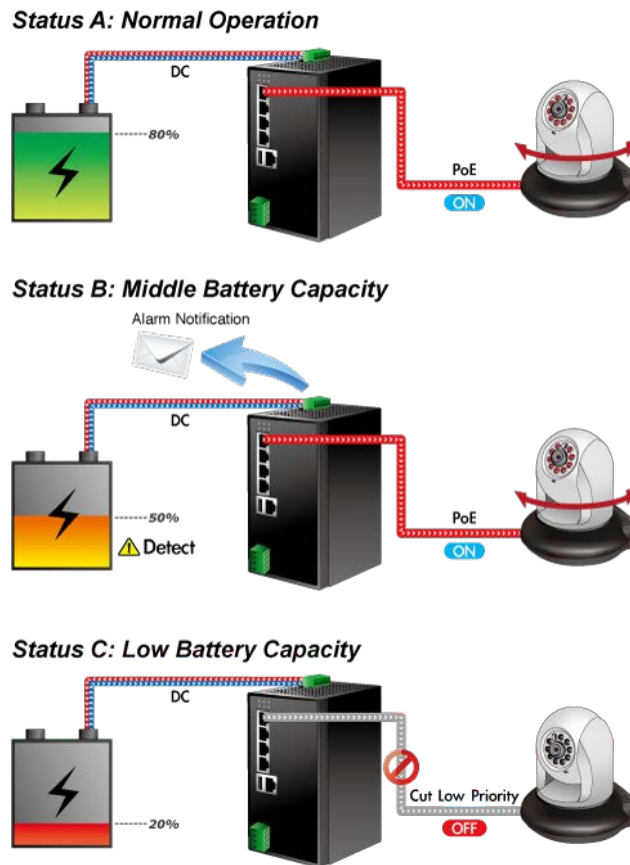
The administrator can remotely access the BSP-360 to know the power status of the battery and renewable energy, and the estimated time of power consumption.





## Low Voltage Cut-Off Protection

If the power is too low to empower the system and IP devices, the system will automatically power off the device with low priority to make sure the system works normally, and an alert is then sent to the administrator at the same time.



## Built-in Unique PoE Functions for Powered Device Management

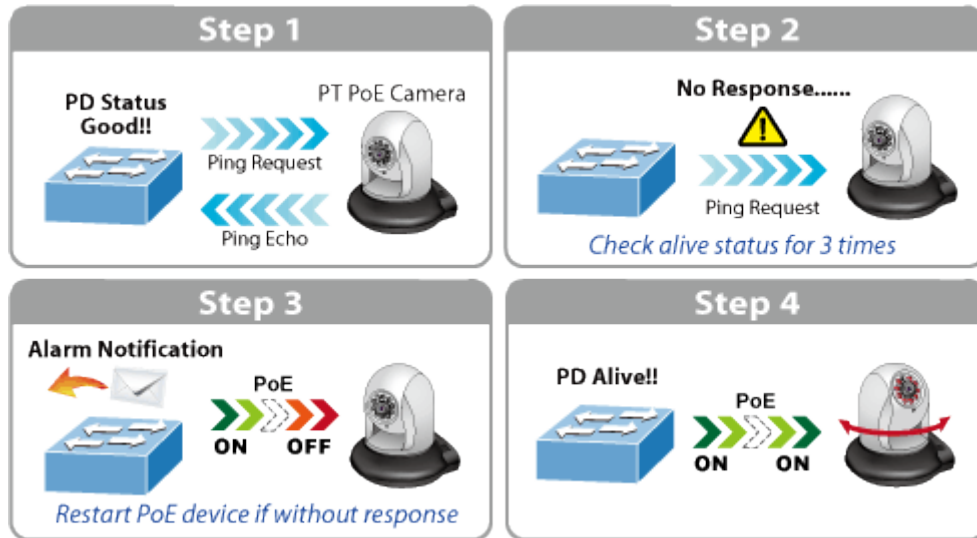
As it is the managed PoE switch for surveillance, wireless and VoIP networks, the BSP-360 features the following special PoE management functions:

- PD alive check
- Scheduled power recycling
- PoE schedule
- PoE usage monitoring

## Intelligent Powered Device Alive Check

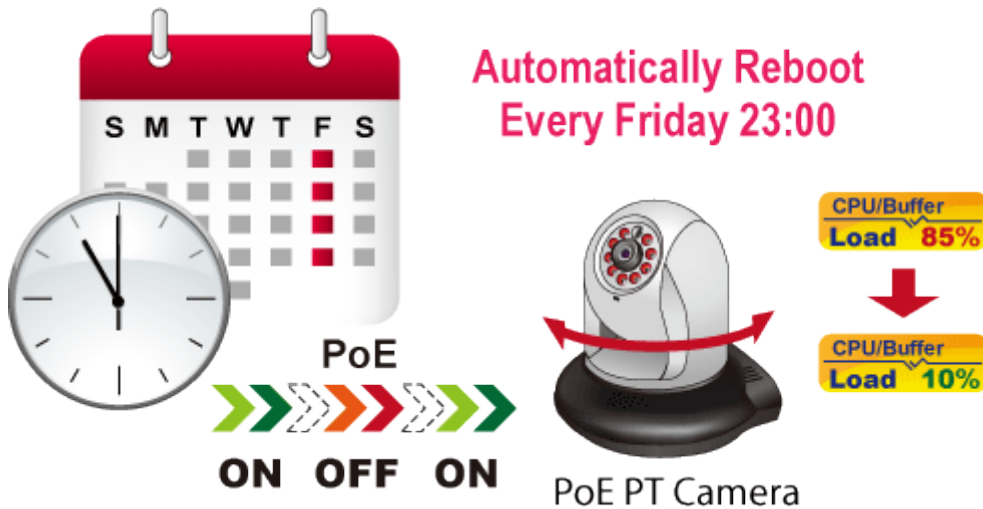
The BSP-360 can be configured to monitor connected PD (Powered Device) status in real time via ping action. Once the PD stops working and responding, the BSP-360 will resume the PoE port power and bring the PD back to work. It will greatly enhance the network reliability through the PoE port resetting the PD's power source and reducing administrator management burden.





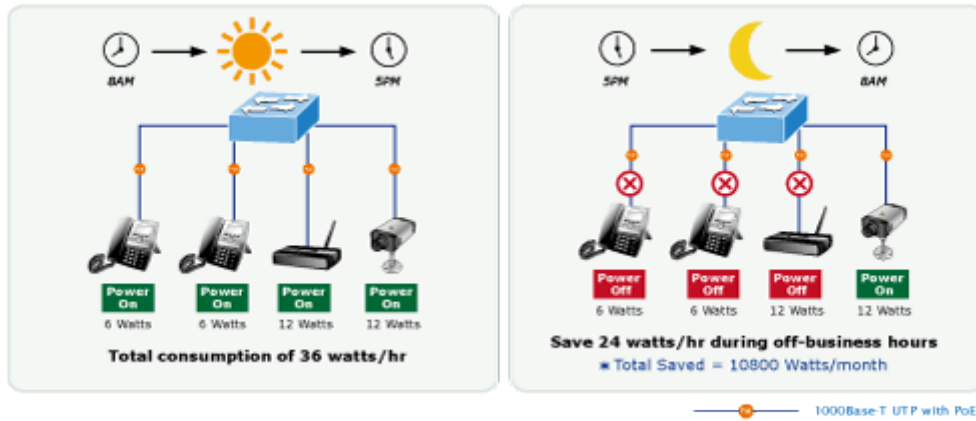
**Scheduled Power Recycling**

The BSP-360 allows each of the connected PoE IP cameras or PoE wireless access points to reboot at a specific time each week. Therefore, it will reduce the chance of IP camera or AP crash resulting from buffer overflow.



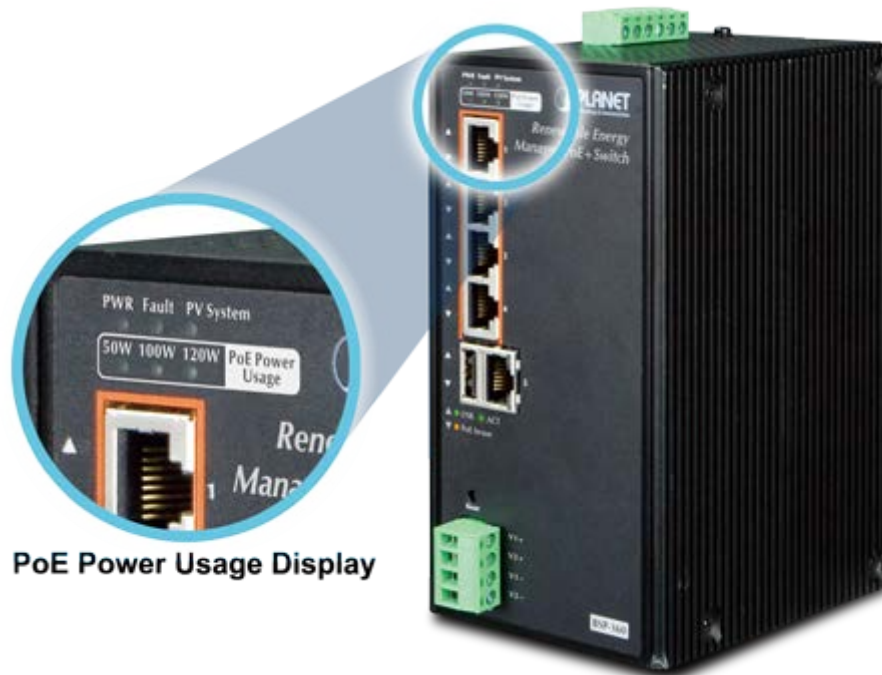
**PoE Schedule for Energy Saving**

Under the trend of energy saving worldwide and contributing to environmental protection, the BSP-360 can effectively control the power supply besides its capability of giving high watts power. The “PoE schedule” function helps you to enable or disable PoE power feeding for each PoE port during specified time intervals and it is a powerful function to help SMBs or enterprises save power and budget. It also increases security by powering off PDs that should not be in use during non-business hours.



### PoE Usage Monitoring and Intelligent LED Indicator for Real-time PoE Usage

Via the power usage chart in the web management interface, the BSP-360 enables the administrator to monitor the status of the power usage of the connected PDs in real time. Thus, it greatly enhances the management efficiency of the facilities. Moreover, the BSP-360 helps users to monitor the current status of PoE power usage easily and efficiently via its advanced LED indication. Called “**PoE Power Usage**”, the front panel of the BSP-360 has three LED indicators of different power usages.



### Friendly and Secure Management

For efficient management, the BSP-360 is equipped with **WEB** and **SNMP** management interfaces. With the built-in web-based management interface, the BSP-360 offers an easy-to-use, platform-independent management and configuration facility. By supporting the standard SNMP, the switch can be managed via any standard management software. Moreover, the BSP-360 offers secure remote management by supporting SSL and SNMP connections which encrypt the packet content at each session.

## 1.3 How to Use This Manual

This User Manual is structured as follows:

### ■ Section 2, Installation

It explains the functions of Renewable Energy Switch and how to physically install the Renewable Energy Switch.

### ■ Section 3, Management

It contains information about the software function of the Renewable Energy Switch.

### ■ Section 4, Web Configuration

The section explains how to manage the Renewable Energy Switch through Web interface.

### ■ Section 5, Power over Ethernet overview

The section explains the Power over Ethernet theories.

### ■ Section 6, PoE Power Provision Process

The section explains the PoE power provision process.

### ■ Appendix A

It contains cable information of Renewable Energy Switch.

### ■ Appendix B

It contains AWG cable and battery information of Renewable Energy Switch.

## 1.4 Product Features

### ➤ Physical Port

- 5-port 10/100/1000BASE-T Gigabit RJ45 copper with 4-port IEEE 802.3at/af PoE Injector (Port 1 to Port 4)
- RJ45 type interface for basic management and setup
- USB type A female for setting file backup and restore

### ➤ Power over Ethernet

- Complies with IEEE 802.3at Power over Ethernet Plus end-span PSE
- Backward compatible with IEEE 802.3af Power over Ethernet
- Up to 4 ports of IEEE 802.3af/802.3at devices powered
- Supports PoE power up to 30 watts for each PoE port
- Auto detects powered device (PD)
- Circuit protection prevents power interference between ports
- Remote power feeding up to 100 meters
- PoE management
  - Total PoE power budget control
  - Per port PoE function enable/disable
  - PoE port power feeding priority
  - Per PoE port power limitation
  - PD alive-check
  - PoE schedule

### ➤ Battery Management

- Battery type option: Nickel-cadmium battery or lead-acid battery
- Easy diagnostic of the system operating status via LED indicator
- Battery current usage and status
- Battery capacity and power consumption statistics
- Low voltage cut-off protection: Send alert and cut off the low priority PoE port for the low power battery
- Pulse Width Modulation (PWM) Protection
  - Reverse current protection to prevent the current circuits from flowing back to the PV panel
  - Over-current and over-temperature protection
  - Reverse polarity protection (for battery and charging electrodes)

### ➤ Industrial Case & Installation

- IP30 aluminum case
- DIN-rail and wall-mounted design

- Supports -10 to 60 degrees C operating temperature
- Supports ESD 6KV DC Ethernet protection
- Redundant power design
  - 24V~45V DC wide power input

### ➤ **Switching**

- Hardware based 10/100Mbps (half/full duplex), 1000Mbps (full duplex), auto-negotiation and auto MDI/MDI-X
- Features Store-and-Forward mode with wire-speed filtering and forwarding rates
- IEEE 802.3x flow control for full duplex operation and back pressure for half duplex operation
- 8K MAC address table size
- Automatic address learning and address aging

### ➤ **Router**

- Internet types: Dynamic IP, static IP, PPPoE, L2TP, PPTP
- Static and dynamic (RIP1 and 2) routing
- IP/MAC-based bandwidth control
- Supports Port Forwarding, DMZ, UPnP and Dynamic DNS for various networking applications
- 802.1d STP and IGMP Proxy

### ➤ **Security**

- Port filtering lets you either allow or prevent which applications can access the Internet.
- MAC filtering allows you to include or exclude computers and devices based on their MAC address
- URL filtering allows you to control access to Internet websites in an URL list
- IP source guard prevents IP spoofing attacks
- DoS attack prevention

### ➤ **Security**

- Switch Management Interface
  - IPv4 Web switch management
  - SNMP v1, v2c
- Static and DHCP for IP address assignment
- System Maintenance
  - Firmware upload/download via HTTP
  - Configuration upload/download through HTTP
  - Hardware reset button for system reboot or reset to factory default
- NTP Network Time Protocol
- SNMP trap for interface Link Up and Link Down notification
- Event message logging to remote syslog server
- PLANET Smart Discovery Utility

## 1.5 Product Specifications

Product	BSP-360
<b>Hardware Specifications</b>	
Copper Ports	LAN: 5 10/100/1000Mbps auto MDI/MDI-X RJ45 port (Port-1 to Port-5, bridge mode) WAN: 1 10/100/1000Mbps auto MDI/MDI-X RJ45 port (Port-5, gateway mode)
PoE Injector Port	4 ports with 802.3af/802.3at PoE injector function (Port-1 to Port-4)
USB	1 USB Type A female for setting backup
Power Output	4 PoE out 52VDC; max. 30 watts per PoE port 1 DC out 24@ 1A maximum (four-pin terminal block) <i>* The voltage of DC out is based on the battery.</i>
Switch Architecture	Store-and-Forward
Switch Fabric	10Gbps/non-blocking
Switch Throughput@64 bytes	5.95Mpps@64 bytes
MAC Address Table	8K entries
Shared Data Buffer	512Kbit
Flow Control	IEEE 802.3x pause frame for full-duplex Back pressure for half-duplex
Reset Button	< 5 sec: System reboot > 5 sec: Factory default
LED	3 LEDs for System and Power: <ul style="list-style-type: none"> <li>■ <b>Green:</b> Power</li> <li>■ <b>Green:</b> Fault</li> <li>■ <b>Green:</b> System</li> </ul> 4 LEDs for PoE Copper Ports (Port-1~Port-4): <ul style="list-style-type: none"> <li>■ <b>Green:</b> LNK/ACT</li> <li>■ <b>Orange:</b> PoE-in-use</li> </ul> 1 LED for 10/100/1000T Copper Port (Port-5): <ul style="list-style-type: none"> <li>■ <b>Green:</b> LNK/ACT</li> </ul> 3 LEDs for PoE Power Usage (W) <ul style="list-style-type: none"> <li>■ <b>Green:</b> 50, 100 and 120W</li> </ul>
Connector	Removable 6-pin terminal block Pin 1/2 for PV panel; Pin 3/4 for alarm; Pin 5/6 for battery
Alarm	1 Digital Output (DO):

	<p>Level 0: -24V~2.1V (<math>\pm 0.1V</math>)</p> <p>Level 1: 2.1V~24V (<math>\pm 0.1V</math>)</p> <p>Open collector to 24V DC, 100mA max.</p>
Power Requirements	<p>PV in: 24~45V DC</p> <p>Battery in: 24V DC</p>
Power Consumption/ Dissipation	<p>5.04 watts, 17.1BTU (Standby without PoE function)</p> <p>6.96 watts, 23.7 BTU (Full loading without PoE function)</p> <p>135.36 watts, 461.5 BTU (Full loading with PoE function)</p>
Dimensions (W x D x H)	152 x 107 x 84 mm
Weight	1026g
ESD Protection	6KV DC
Enclosure	IP30 aluminum case
Installation	DIN-rail kit and wall-mount ear
<b>Power over Ethernet</b>	
PoE Standard	IEEE 802.3af/802.3at Power over Ethernet PSE
PoE Power Supply Type	End-span
PoE Power Output	<p>IEEE 802.3af Standard</p> <ul style="list-style-type: none"> <li>■ Per port 48V~56V DC (depending on the power supply), max. 15.4 watts</li> </ul> <p>IEEE 802.3at Standard</p> <ul style="list-style-type: none"> <li>■ Per port 50V~56V DC (depending on the power supply), max. 36 watts</li> </ul>
Power Pin Assignment	1/2 (+), 3/6 (-)
PoE Power Budget	120 watts (PoE consumption + DC out and depending on power input)
Max. Number of Class 2 PDs	4
Max. Number of Class 3 PDs	4
Max. Number of Class 4 PDs	4
<b>Electrical Characteristics</b>	
System Voltage Rating	24V DC
Maximum Charging Current	6A
Max. Solar Array VOC	60V DC
Max. Operating Voltage	45V DC
Total Current Consumption	<p>While operating -32Ma</p> <p>At idle -11mA</p>
High Temperature Shutdown	<p>100 degrees C disconnect solar and load</p> <p>80 degrees C reconnect solar and load</p>



Battery Charging Characteristics	
Charge Algorithm	Bulk charge (constant current), Absorption charge (constant voltage) and Floating charge. Absorption and Floating charge with PWM protection.
Maximum Output Current	6A
Nickel-cadmium Battery	± 40 mV/degrees Celsius for NiCad type batteries; charge cut-off @ 55 degrees C (Temperature compensation baseline@ 25 degrees C)
Lead Acid Battery (Default Setting)	± 60 mV/degrees Celsius for lead acid type batteries; charge cut-off @ 55 degrees C (Temperature compensation baseline@ 25 degrees C)
Float Charge Voltage	DC 27.2V (26.0~30.0V)
Absorption Charge Voltage	DC 29.2V (28.0~32.0V)
LVD (Low Voltage Disconnection)	DC 22.2V (21.0~25.0V)
LVR (Low Voltage Reconnection)	DC 24.8V (23.0~27.0V)
Router Features	
Internet Connection Type	Shares data and Internet access with users, supporting the following internet accesses: <ul style="list-style-type: none"> <li>■ PPPoE</li> <li>■ Dynamic IP</li> <li>■ Static IP</li> <li>■ PPTP</li> <li>■ L2TP</li> </ul>
Firewall	NAT firewall with SPI (Stateful Packet Inspection) Built-in NAT server supporting Port Forwarding, and DMZ Built-in firewall with IP address/MAC address/Port/ URL filtering Supports ICMP-FLOOD, UDP-FLOOD, TCP-SYN-FLOOD filter, DoS protection
Routing Protocol	Static/Dynamic (RIP1 and 2) routing
VPN Pass-through	PPTP, L2TP, IPSec, IPv6
LAN	Built-in DHCP server supporting static IP address distribution Supports UPnP, Dynamic DNS Supports IGMP Proxy Supports 802.1d STP (Spanning Tree) IP/MAC-based bandwidth control
Management	
Management Interface	Setup of system/management functions

	<p>Web firmware upgrade</p> <p>SNMP trap for alarm notification of events</p>
PoE Management	<p>Power limit by consumption and allocation</p> <p>PoE admin mode</p> <p>Per port power schedule</p> <p>Per port power enable/disable</p> <p>Power feeding priority</p> <p>Current per port usage and status</p> <p>Total power consumption</p> <p>PD alive check</p> <p>Scheduled power recycling</p>
Battery Management	<p>Battery current usage and status</p> <p>Battery capacity statistics</p> <p>Low Voltage Cut-Off Protection</p>
<b>Standards Conformance</b>	
Regulatory Compliance	FCC Part 15 Class A, CE
Standards Compliance	<p>IEEE 802.3 10BASE-T Ethernet</p> <p>IEEE 802.3u 100BASE-TX Fast Ethernet</p> <p>IEEE 802.3ab 1000BASE-T Gigabit Ethernet</p> <p>IEEE 802.3x Flow Control and Back Pressure</p> <p>IEEE 802.1D Spanning Tree Protocol</p> <p>IEEE 802.3at Power over Ethernet Plus</p> <p>IEEE 802.3af Power over Ethernet</p> <p>RFC 768: UDP</p> <p>RFC 791: IP</p> <p>RFC 2068 HTTP</p> <p>RFC 1157: SNMP v1</p> <p>RFC 1902: SNMP v2c</p> <p>RFC 5424: Syslog</p>
<b>Environment</b>	
Operating	<p>Temperature: -10 ~ 60 degrees C</p> <p>Relative Humidity: 5 ~ 95% (non-condensing)</p>
Storage	<p>Temperature: -10 ~ 70 degrees C</p> <p>Relative Humidity: 5 ~ 95% (non-condensing)</p>

## 2. INSTALLATION

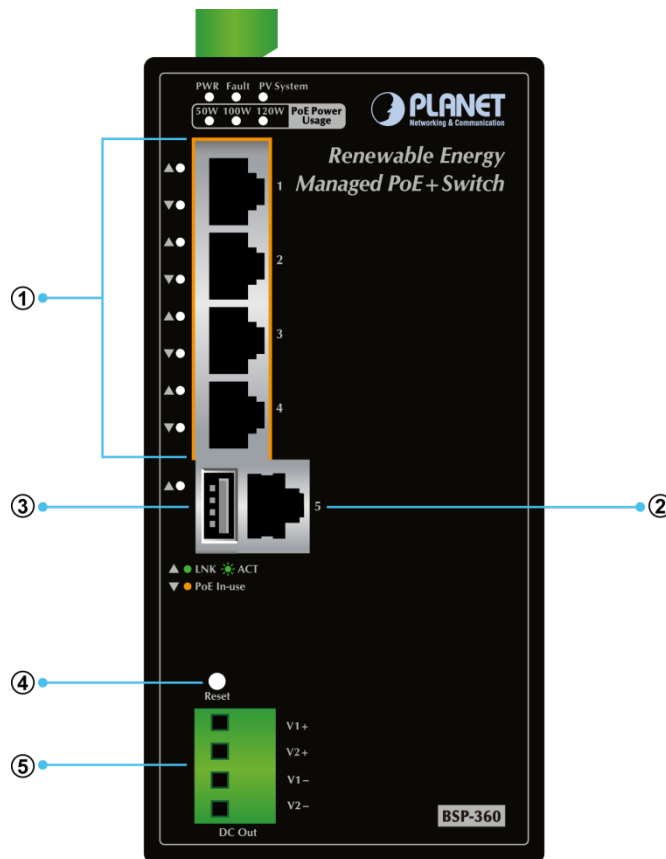
This section describes the hardware features of Renewable Energy Switch. For easier management and control of the Renewable Energy Switch, familiarize yourself with its display indicators and ports. Front panel illustrations in this chapter display the unit LED indicators. Before connecting any network device to the Renewable Energy Switch, read this chapter carefully.

### 2.1 Hardware Description

The section describes the hardware of the Renewable Energy Switch and gives a physical and functional overview.

#### 2.1.1 Injector Front Panel

<b>Dimensions (W x D x H)</b>	152 x 107 x 84 mm
<b>Weight</b>	1.03kg (gross weight)



Item	Interface	Description
1	Port-1~Port-4	4 10/100/1000BASE-T RJ45 auto-MDI/MDI-X ports with <b>802.af/at PoE+</b> injector function.
2	Port-5	One 10/100/1000BASE-T RJ45 auto-MDI/MDI-X port. Port-5 functions as <b>WAN</b> port when the operation mode of BSP-360 is configured to " <b>Gateway mode</b> "
3	USB	Connect the USB storage to USB port and back up the configuration file.
4	Reset Button	< 5 seconds: System reboot. > 5 seconds: Factory default.
5	4-pin Terminal Block	<b>24V DC output</b> connector. The output voltage is the same as battery voltage. Maximum voltage is clamped at 24V, 1A.

## 2.1.2 LED Indicators

The front panel LEDs indicates instant status of system power, PoE and PV system failure, management port Link/Active, PoE power usage status and per PoE port links status, thus helping administrator to monitor and troubleshoot when needed.

### System

LED	Color	Function	
PWR	Green	On	To indicate BSP-360 has power.
Fault	Green	Slow Blinks	To indicate the PV is <b>disconnected</b> .
		Fast Blinks	To indicate the battery voltage is less than the value for low-voltage disconnection.
		On	To indicate <b>bad battery, over-current</b> or <b>short-circuit</b> .
PV System	Green	Slow Blinks	To indicate the system is " <b>on</b> ".
		Fast Blinks	To indicate the battery is " <b>charging</b> ".
50W	Green	On	To indicate the system consumes over <b>50-watt</b> PoE power budget.
100W	Green	On	To indicate the system consumes over <b>100-watt</b> PoE power budget.
120W	Green	On	To indicate the system consumes the total <b>120-watt</b> PoE power budget.

### PoE 10/100/1000BASE-T Interfaces (Port-1 to Port-4)

LED	Color	Function	
LNK/ACT	Green	Blinks	To indicate the link through that port is successfully established.
PoE	Orange	Lights	To indicate the port is providing DC in-line power.

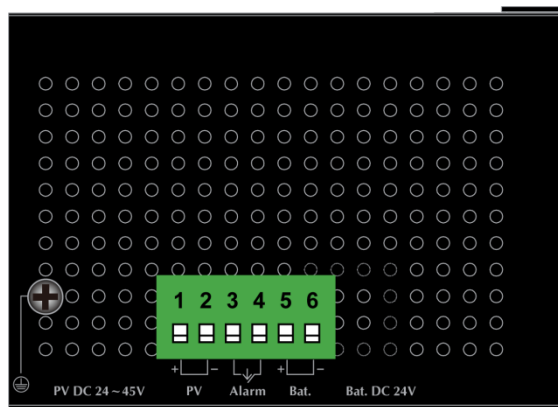
LED	Color	Function
		<b>Off</b> To indicate the connected device is not a PoE Powered Device (PD).

### 10/100/1000BASE-T Interfaces (Port-5)

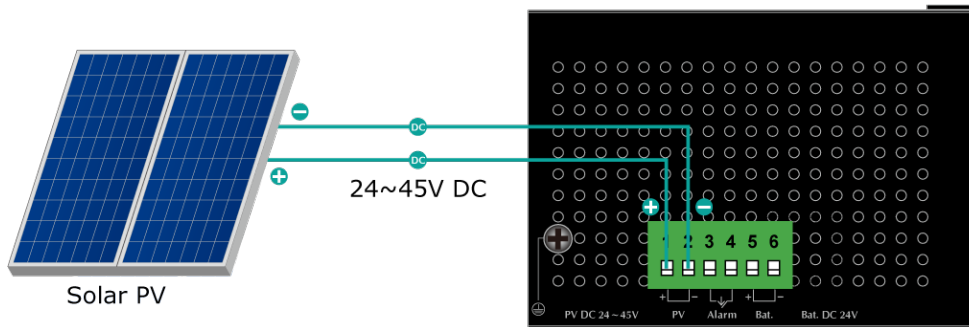
LED	Color	Function
<b>LNK/ACT</b>	<b>Green</b>	<b>Blinks</b> To indicate the link through that port is successfully established.

## 2.1.3 Switch Upper Panel

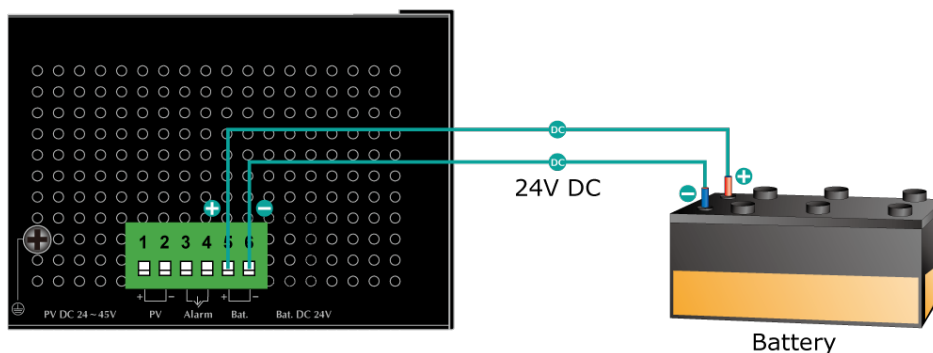
The Upper Panel of the Renewable Energy Switch comes with a DC inlet power socket and one terminal block connector with 6 contacts.



### PV In Connector



### Battery In/Out

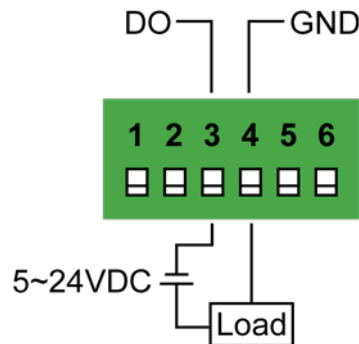




The wire gauge for the terminal block should be in the range from **14 to 24 AWG**.

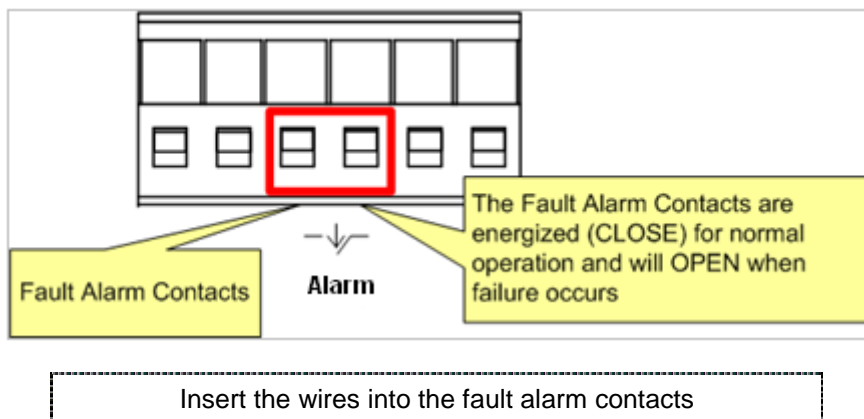
## DO Connectors

- Level 0: -24V~2.1V ( $\pm 0.1V$ )
- Level 1: 2.1V~24V ( $\pm 0.1V$ )



### 2.1.4 Wiring the Fault Alarm Contact

The fault alarm contacts are in the middle (3 & 4) of the terminal block connector as the picture shows below. Inserting the wires, the Renewable Energy Switch will detect the fault status of the power failure, or port link failure (available for managed model). The following illustration shows an application example for wiring the fault alarm contacts



1. The wire gauge for the terminal block should be in the range of **14 ~ 24 AWG**.
2. When performing any of the procedures like inserting the wires or tightening the wire-clamp screws, make sure the power is OFF to prevent from getting an electric shock.

## 2.1.5 Wiring the Digital Output

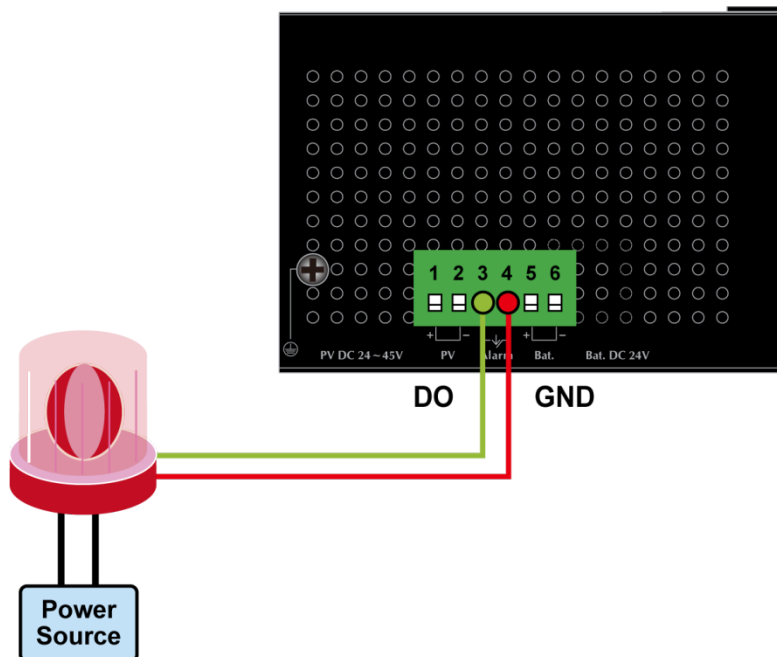
The 6-contact terminal block connector on the rear panel of BSP-360 and the 3/4 pin is used for Digital Output. Please follow the steps below to insert wire.

The BSP-360 offers one DO groups. **3 is DO and 4 is GND**. Please tighten the wire-clamp screws for preventing the wires from loosening.



1	2	3	4	5	6
PV+	PV-	DO	GND	Bat+	Bat-

There are one Digital Output groups for you to sense BSP-360 port failure or power failure and issue a high or low signal to external device. The following topology shows how to wire DO and GND.



## 2.2 Installing the Renewable Energy Switch

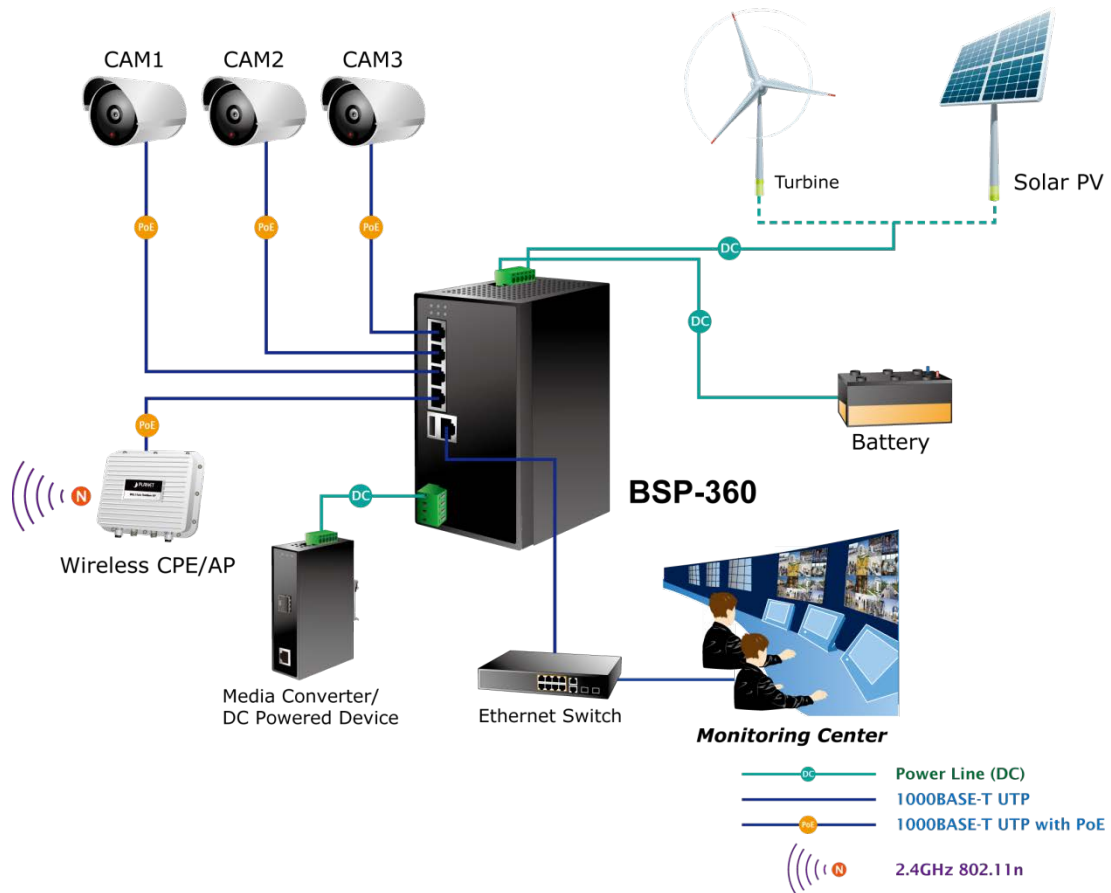
This section describes how to install your Renewable Energy Switch and make connections to the Renewable Energy Switch. Please read the following topics and perform the procedures in the order being presented. Please read the following topics and perform the procedures in the order being presented. To install your Renewable Energy Switch on a desktop or shelf, simply complete the following steps.



In this paragraph, we will describe how to install the Renewable Energy Switch and the installation points attended to it.

## 2.2.1 Installation Steps


The following section describes the hardware installation of the BSP-360. Before connecting any network device to the BSP-360, read this chapter carefully.



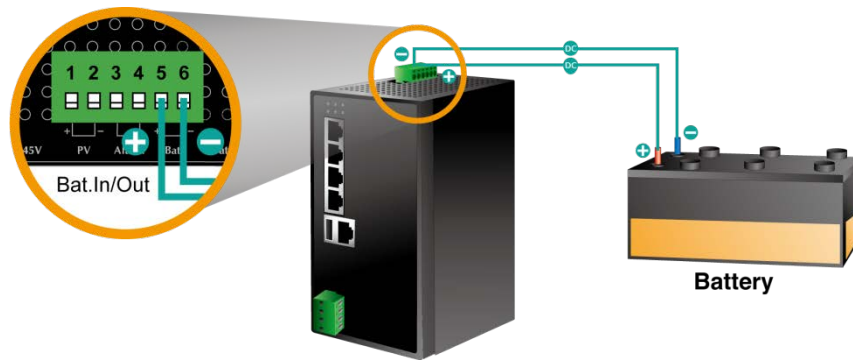
Please follow the following steps to install the system:

### Step 1. Install BSP-360

Place the BSP-360 in a desired location using the wall-mount fixtures.

 <b>Note</b>	<p>Please install the BSP-360 in a proper enclosure or shelter. The BSP-360 must be grounded.</p>
--	---

## Step 2. Install battery



- (1) Connect the **negative electrode of the battery** to the terminal for the **negative electrode of the battery on the BSP-360**.
- (2) Connect the **positive electrode of the battery** to the terminal for the **positive electrode of the battery on the BSP-360**.
- (3) After the battery is well connected to the BSP-360, the **PWR LED will be ON** and **System LED will slowly blink**, and **Fault LED will slowly blink** for PV not connected.



The BSP-360 accepts the **24V DC** battery system. Please pay attention to the battery characteristics and also refer to the section -- **Recommended Settings for Different Batteries** in the Quick Installation Guide.



Note

Be noted for the thickness of electric wire and please refer to the section -- **Recommended Use of the Connected Wires** in the Quick Installation Guide.

The default **LVD (Low Voltage Disconnection)** is set at **22.2V DC**; we suggest charge the voltage of battery to **23.5V DC or above** for the BSP-360.



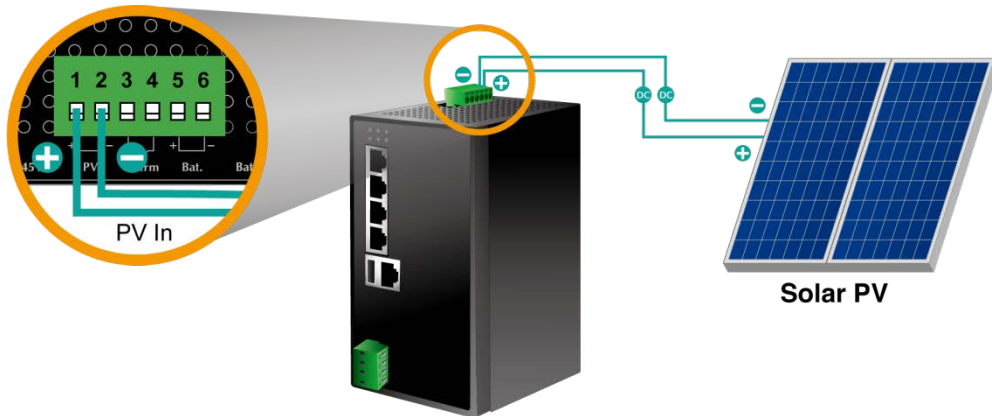
Check the total power consumption of your connected network device before installation. Improper battery capacity could shorten the battery life or make your network device lack of power supply.




Note

Please link PLANET download center and download **BSP360-PV&BAT\_calculation**. The calculation list can help you to select solar panel and battery.

**Step 3. Install PV Panel**

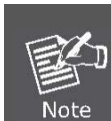


- (1) Connect the **negative electrode of the PV panel** to the terminal for the **negative electrode of the PV panel on the BSP-360**.
- (2) Connect the **positive electrode of the PV panel** to the terminal for the **positive electrode of the PV panel on the BSP-360**.
- (3) After the PV is well connected to the BSP-360 and providing 24V or above voltage, the **System LED will blink fast for battery charge if the battery is not full**. And **Fault LED will turn off**.

 Be noted for the thickness of electric wire and please refer to the section -- **Recommended Use of the Connected Wires** in the Quick Installation Guide. Check the total power consumption of your device and the sunshine duration of your area from the weather bureau for a proper PV. Improper PV could shorten the battery life or provide insufficient power to the BSP-360.

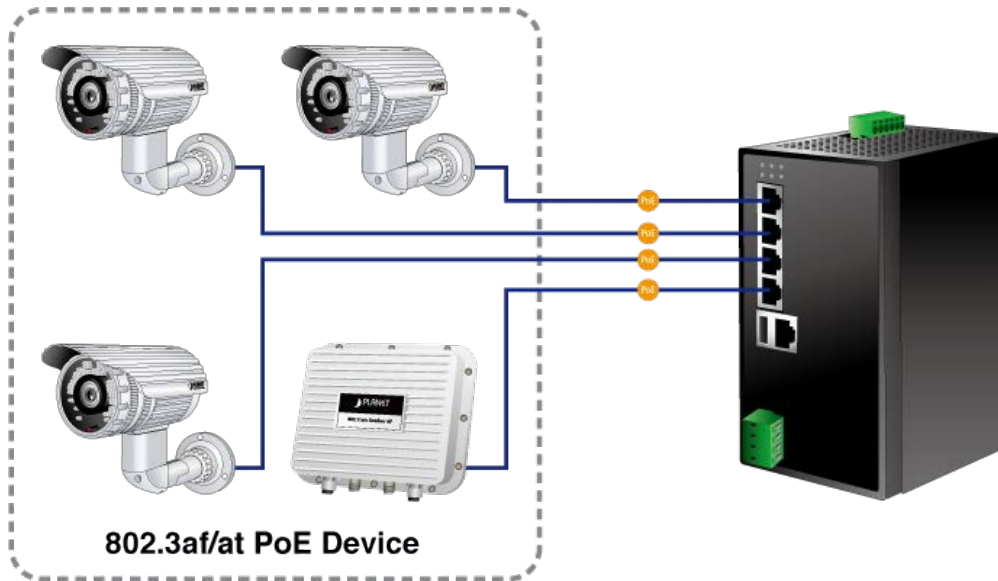


The BSP-360 supports a maximum of **45V DC input**.




Please link PLANET download center and download **BSP360-PV&BAT\_calculation**. The calculation list can help you to select solar panel and battery.

#### Step 4. Connect 802.3af/802.3at PoE Device



Connect the PoE devices to ports 1~ 4 on the BSP-360.

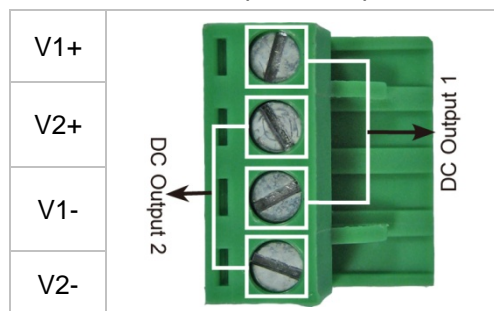
Check the PoE-in-Use LED. If the network devices such as PoE camera and PoE wireless AP are powered, the **PoE-in-use LED will turn ON** and **Link/Act LED will blink** for a successful connection or data receiving.

 Note	<p>Please use <b>Cat5/5e or above cable</b> and the maximum distance should within <b>100 meters</b>.</p> <p>If the Network devices are installed outdoors, please consider to install a lightning arrester to protect the network device and the BSP-360.</p>
---	--

#### Step 5. Wiring the DC Outputs

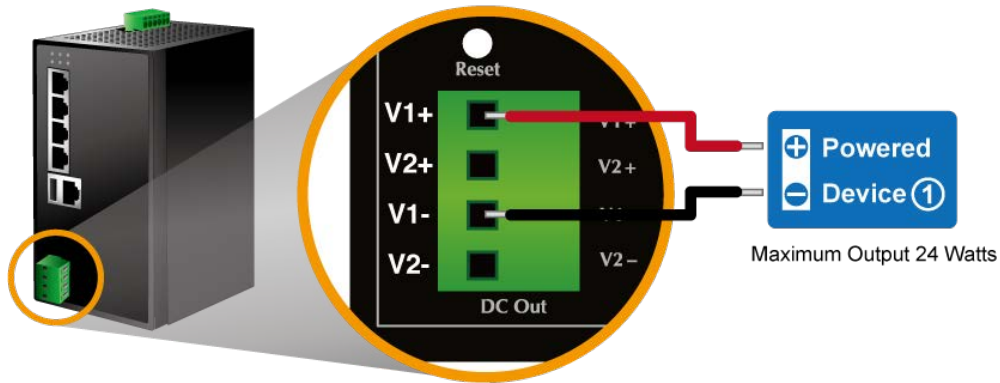
Please follow the steps below to insert the power wires for DC power required equipment.

Please find the terminal block connector with two DC power outputs shown below:

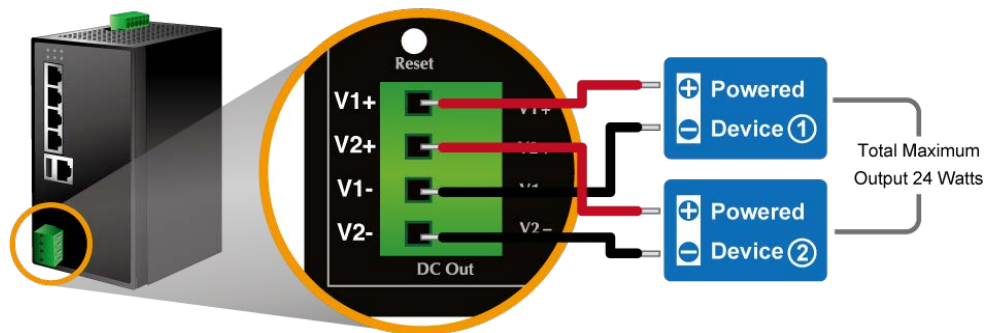


Insert the **Positive and Negative DC wires** into the **V+ and V- terminals**, respectively; Terminals 1 and 3 for Power 1, and Terminals 2 and 4 for Power 2.

Connect the other points of DC power wires to the power devices. Tighten the wire-clamp screws for preventing the wires from loosening.



One Powered Device



Two Powered Devices

Install the terminal block on the BSP-360.



Note

The voltage of DC out is based on the battery voltage and the maximum DC out from the BSP-360 is **24VDC, 1A**.

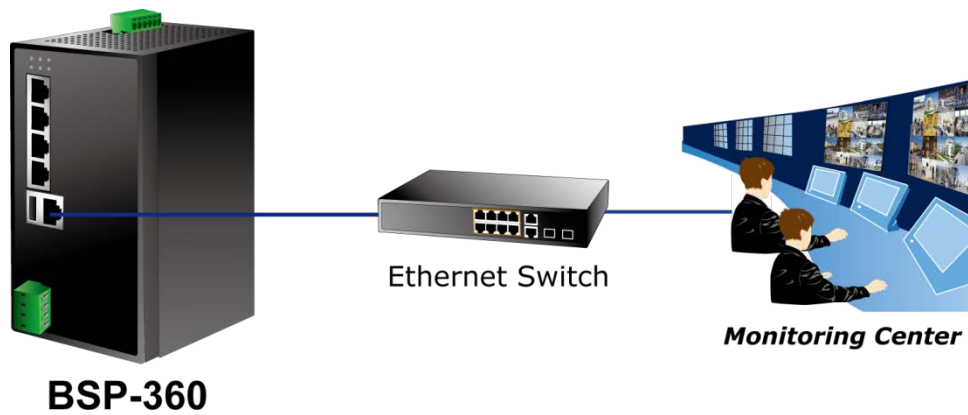
The wire gauge for the terminal block should be in the range from **14 to 24 AWG**.

The external device should also be grounded properly.



Please ensure the output voltage is correct for remote device. Otherwise, it will damage your remote device.

**Step 6. Connect to PC**



After completing the above 6 steps, the BSP-360 are ready for service.

### 2.2.2 DIN-rail Mounting

This section describes how to install the Renewable Energy Switch. There are two methods to install the Renewable Energy Switch -- DIN-rail mounting and wall-mount plate mounting. Please read the following topics and perform the procedures in the order being presented.



**Follow all the DIN-rail installation steps as shown in the example.**

**Step 1: Screw the DIN-rail on the Renewable Energy Switch.**



**Step 2:** Lightly slide the DIN-rail into the track.



**Step 3:** Check whether the DIN-rail is tightly on the track.

Please refer to the following procedures to remove the Renewable Energy Switch from the track.

**Step 4:** Lightly remove the DIN-rail from the track.







### 2.2.3 Wall Mount Plate Mounting

To install the Renewable Energy Switch on the wall, please follow the instructions below.



**Follow all the DIN-rail installation steps as shown in the example.**

**Step 1:** Remove the DIN-rail from the Renewable Energy Switch. Use the screwdriver to loosen the screws to remove the DIN-rail.

**Step 2:** Place the wall-mount plate on the rear panel of the Renewable Energy Switch.



**Step 3:** Use the screwdriver to screw the wall mount plate on the Renewable Energy Switch.

**Step 4:** Use the hook holes at the corners of the wall mount plate to hang the Renewable Energy Switch on the wall.

**Step 5:** To remove the wall mount plate, reverse the steps above.

## 3. MANAGEMENT

This chapter describes how to manage the Renewable Energy Switch with the following topics included:

- Overview
- Requirements
- Management Method

### 3.1 Overview

The Renewable Energy Switch provides a user-friendly, Web interface where you can perform various device configuration and management activities, including:

- **System**
- **SNMP**
- **Power over Ethernet**
- **Battery Management**

### 3.2 Requirements

PLANET BSP-360 provides a remote login interface for management purposes. The following equipment is necessary for further management:

- **Workstation** is installed with Ethernet NIC (Network Interface Card)
- Choice of Internet browsers includes Windows XP/2003, Vista, Windows 7, Windows 8, Windows 10, MAC OS X, Linux, Fedora, Ubuntu or other platforms compatible with TCP/IP protocols.
  - The above workstation is installed with Web browser and JAVA runtime environment plug-in.
- **Ethernet Port** connection
  - Use standard network (UTP) cables with RJ45 connectors.
- **PV and battery**
  - **Two 12V batteries** connected in series.
  - The maximum operating voltage of PV is **45V**



It is recommended to use Internet Explorer 10.0 or above to access the BSP-360.

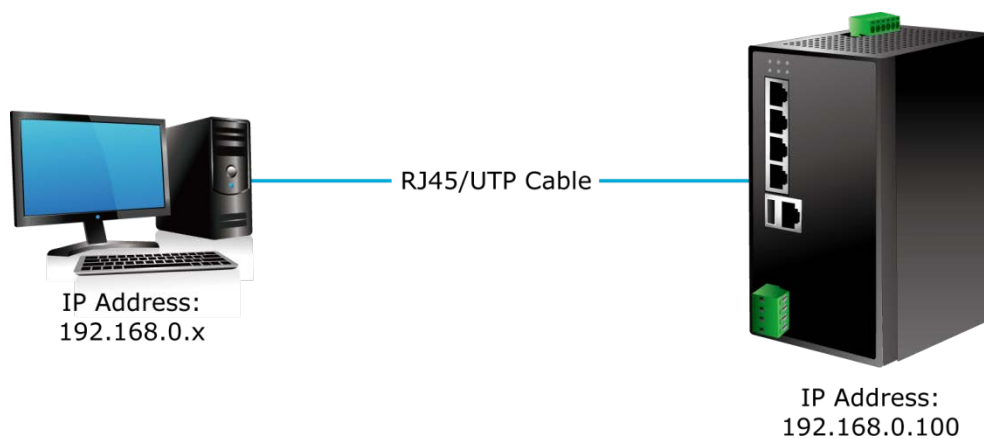
### 3.3 Management Method

User can manage the Renewable Energy Switch by Web Management via a network connection.

### 3.3.1 Web Management

The Renewable Energy Switch can be configured through an Ethernet connection. The factory default IP address is **192.168.0.100** with subnet mask **255.255.255.0**, so please make sure the manager PC must be set to the same **IP subnet address**. For example, if Renewable Energy Switch IP address is set to factory default, then your manager PC should be set to **192.168.0.x** (where x is a number between 1 and 254, except 100) with a subnet mask of **255.255.255.0**.

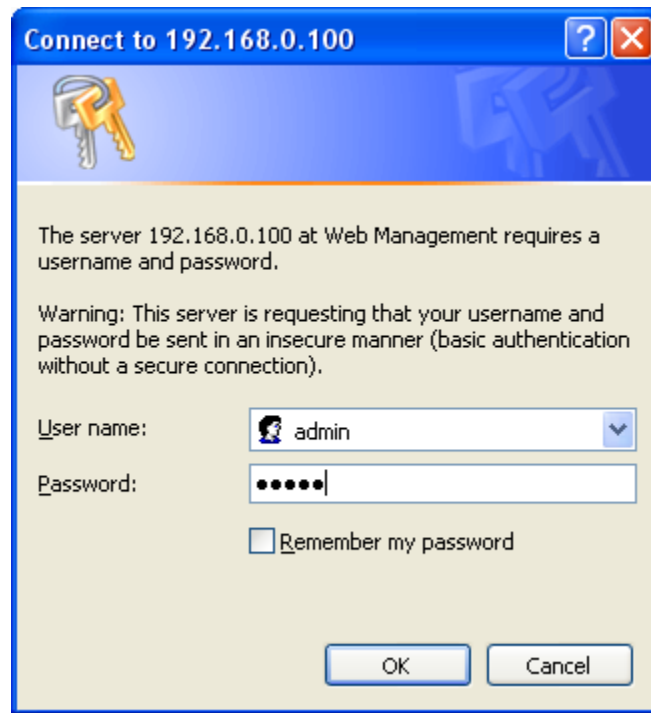
- (1) Use Internet Explorer 10.0 or above Web browser. Enter IP address **http://192.168.0.100** to access the Web interface.



**Figure 3-3-1: IP Management Diagram**

- (2) When the following login screen appears, please enter the default username "**admin**" and password "**admin**" to login the main screen of **Renewable Energy Switch**. The login screen in [Figure 3-3-2](#) appears.

Default IP Address: **192.168.0.100**  
Default Account: **admin**  
Default Password: **admin**



**Figure 3-3-2:** Renewable Energy Switch Web Login Screen



1. For security reason, please change and memorize the new password after this first setup.
2. Only accept command in lowercase letter under Web interface.

### **3.3.2 PLANET Smart Discovery Utility**

For easily listing the Renewable Energy Switch in your Ethernet environment, Planet Smart Discovery Utility from PLANET download center is an ideal solution.

The following installation instructions guide you to running Planet Smart Discovery Utility.

Deposit Planet Smart Discovery Utility in administrator PC.

Run this utility and the following screen appears.

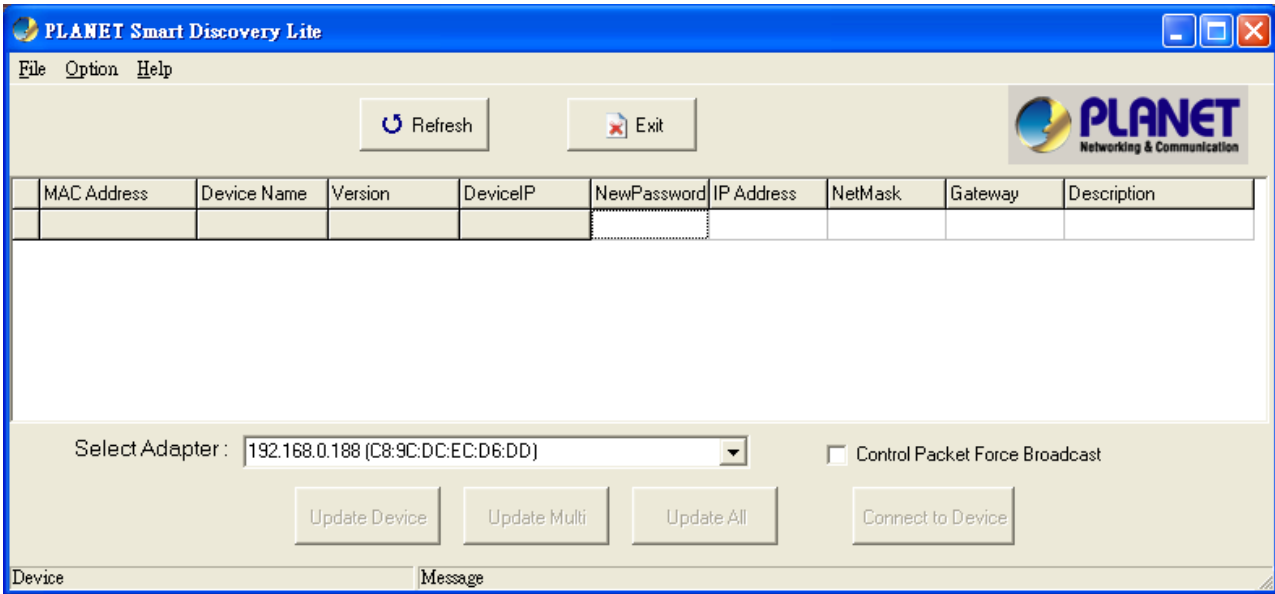



Figure 3-3-3: Planet Smart Discovery Utility Screen



If there are two LAN cards or above in the same administrator PC, choose a different LAN card by using the **“Select Adapter”** tool.

Press the **“Refresh”** button for the currently-connected devices in the discovery list and the screen is shown as follows:

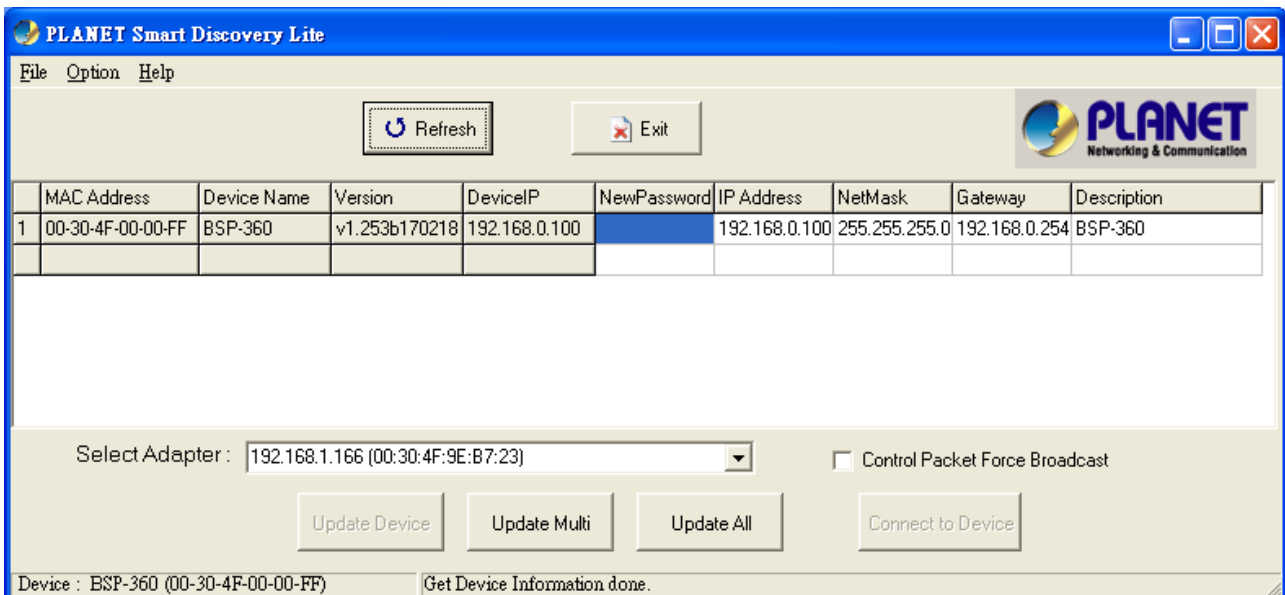


Figure 3-3-4: Planet Smart Discovery Utility Screen

This utility shows all necessary information from the devices, such as MAC address, device name, firmware version and device IP subnet address. It can also assign new password, IP subnet address and description of the devices.

After setup is completed, press the “**Update Device**”, “**Update Multi**” or “**Update All**” button to take effect. The definitions of the 3 buttons above are shown below:

**Update Device:** Use current setting on one single device.

**Update Multi:** Use current setting on multi-devices.

**Update All:** Use current setting on whole devices in the list.

The same functions mentioned above also can be found in “**Option**” tools bar.

By clicking the “**Control Packet Force Broadcast**” function, it allows you to assign new setting value to the Ultra PoE Managed Injector Hub under a different IP subnet address.

Press the “**Connect to Device**” button and then the Web login screen appears in [Figure 3-3-2](#).

Press the “**Exit**” button to shut down Planet Smart Discovery Utility.

## 4. WEB CONFIGURATION

The Renewable Energy Switch provides Web interface for PoE smart function configuration and makes the Renewable Energy Switch operate more effectively. They can be configured through the Web browser. A network administrator can manage and monitor the Renewable Energy Switch from the local LAN. This section indicates how to configure the Renewable Energy Switch to enable its smart function.

### 4.1 Main Menu

After a successful login, the main screen appears. The main screen, as shown in [Figure 4-1-1](#), displays the product name, the function menu, and the main information in the center.



Figure 4-1-1: Web Main Menu screen

The descriptions of the four items are as follows:

Object	Description
System	Provides System information of Renewable Energy Switch. <a href="#">Explained in section 4.3</a>
TCP/IP	Provides WAN, LAN and network configuration of Renewable Energy Switch. <a href="#">Explained in section 4.4</a>
Battery Management	Provides Battery Management configuration of Renewable Energy Switch. <a href="#">Explained in section 4.5</a>
PoE Management	Provides PoE Management configuration of Renewable Energy



---

Object	Description
	Switch. <a href="#">Explained in section 4.6</a>
<b>Maintenance</b>	Provides firmware upgrade and setting file restore/backup configuration of Renewable Energy Switch. <a href="#">Explained in section 4.7.</a>

## 4.2 Web Panel

At the top of the Web management page, the active panel displays the power status and the link status of management port and PoE ports.

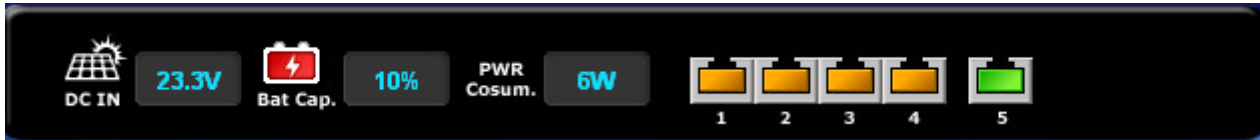


Figure 4-2-1: Web Panel Screen













Object	Icon	Function
DC IN		To indicate the voltage of DC in.
Bat Cap.		To indicate the battery capacity is 70~100%.
		To indicate the battery capacity is 70~100% and charging by solar PV.
		To indicate the battery capacity is 40~69%.
		To indicate the battery capacity is 40~69% and charging by solar PV.
		To indicate the battery capacity is 1~39%.
		To indicate the battery capacity is 1~39% and charging by solar PV.
PWR Cosum.		To indicate the PoE consumption.
LAN		To indicate the LAN do not plug in RJ45 cable.
		To indicate the PoE is in use.
		To indicate the PoE port is disable.
		To indicates network data is sending or receiving

Table 4-2-1: Descriptions of the Web panel Objects

## 4.3 System

The System function provides system information which also allows user to manage the Renewable Energy Switch system as [Figure 4-3-1](#) is shown below:

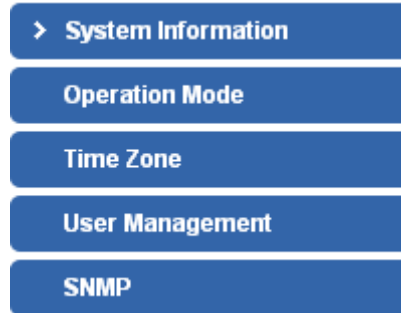


Figure 4-3-1: System Function Menu

The page includes the following information:

Object	Description
System Information	Display the System Status, Statistics, System Log. <a href="#">Explained in section 4.3.1.</a>
Operation Mode	Show the current operation mode, and users can set different modes to LAN interface. <a href="#">Explained in section 4.3.2.</a>
Time Zone	Allow to set system time by manual or synchronize system time from Internet NTP server. <a href="#">Explained in section 4.3.3.</a>
User Management	Allow to change the username and password of Renewable Energy Switch. <a href="#">Explained in section 4.3.4.</a>
SNMP	Provides SNMP Trap information and system information. <a href="#">Explained in section 4.3.5.</a>

### 4.3.1 System Information

This section displays system information of Renewable Energy Switch as [Figure 4-3-2](#) is shown below:

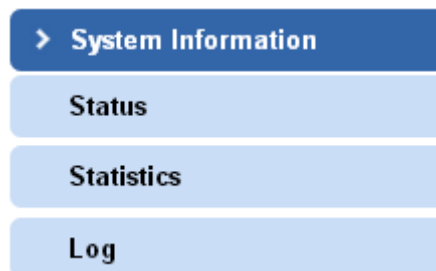


Figure 4-3-2: System Information Menu

### 4.3.1.1 Status

This section displays system information of Renewable Energy Switch as the screen in [Figure 4-3-3](#) appears.

[Table 4-3-1](#) describes the system information of the Renewable Energy Switch.

System Information	
Firmware Version	v1.253b170218
Operating Mode	Bridge
System Temperature	37°C / 99°F
PoE Temperature	48°C / 118°F
System Time	2017/3/8 14:48:32
Network Information	
Attain IP Protocol	Fixed IP
IP Address	192.168.0.100
Subnet Mask	255.255.255.0
Default Gateway	192.168.0.254
DHCP Server	Disabled
MAC Address	00:30:4f:00:00:ff
Power Information	
Battery Type	Lead-acid
Install Time of Battery	2016/8/31
Battery Life	11
Battery Recharge	0
DC Charge Voltage / Current	23.27V / 170.5mA
Battery Load Voltage / Current	23.34V / 0mA
Battery Capacity (approx.)	20.68 %

**Figure 4-3-3:** System Information Web Page Screen

Object	Description
<b>System Information</b>	
<b>Firmware Version</b>	Displays the current firmware version of Renewable Energy Switch.
<b>Operation Mode</b>	Displays the current operation mode.
<b>System Temperature</b>	Displays the current system temperature of Renewable Energy Switch.
<b>PoE Temperature</b>	Displays the current PoE temperature of Renewable Energy Switch.
<b>System Time</b>	Displays the current system date of Renewable Energy Switch. The system date will be correct if NTP function is enabled and the Hub is connected to Internet.
<b>Network Information</b>	
<b>Attain IP Protocol</b>	Displays the currently attained IP protocol of Renewable Energy Switch.
<b>IP Address</b>	Displays the current IP address of Renewable Energy Switch.
<b>Subnet Mask</b>	Displays the current subnet mask address of Renewable Energy Switch.
<b>Default Gateway</b>	Displays the current gateway address of Renewable Energy Switch.
<b>System Name</b>	Displays the Renewable Energy Switch model name.
<b>DHCP Server</b>	IP address of DHCP Server.
<b>MAC Address</b>	Displays the MAC address of Renewable Energy Switch.

Object	Description
<b>Power Information</b>	
<b>Battery Type</b>	Nickel-cadmium or Lead-acid battery. Go to the <b>Battery management</b> to select the battery type.
<b>Install Time of Battery</b>	Displays the install time of battery. Go to the <b>Battery management</b> to enter the install time.
<b>Battery Life</b>	Displays the life of battery. Go to the <b>Battery management</b> to enter the life.
<b>Battery Recharge</b>	Displays the time of battery recharge.
<b>DC Charge Voltage / Current</b>	Displays the voltage and current of DC in.
<b>Battery Load Voltage / Current</b>	Displays the voltage and current of battery.
<b>Battery Capacity (approx.)</b>	Displays the capacity of battery.

Table 4-3-1: Descriptions of the System Information Objects

#### 4.3.1.2 Statistics

This section displays statistics information of battery capacity and PoE consumption as the screen in [Figure 4-3-4](#) appears. [Table 4-3-2](#) describes the system information of the Renewable Energy Switch.

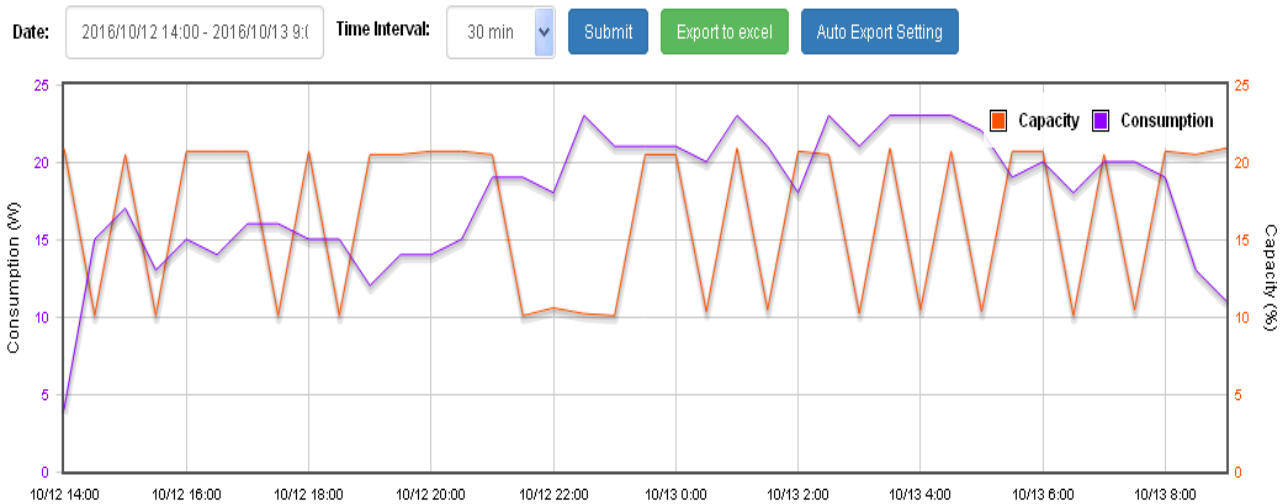



Figure 4-3-4: Statistics Web Page Screen

Object	Description
<b>Consumption</b>	Displays PoE consumption usage per hour.
<b>Capacity</b>	Displays battery capacity per hour.
<b>Date</b>	Select the date to see the battery capacity and PoE consumption per day.

Object	Description
Time Interval	Select 30 min. or 60 min.
Export to excel	Download this data chart excel to PC.
Auto Export Setting	Download this data chart to FTP server.

Table 4-3-2: Descriptions of the Statistics Objects



The statistics will recount after reboot.

### 4.3.1.3 Log

This section provides the system log setting and information display of Renewable Energy Switch as the screen in [Figure 4-3-5](#) appears. [Table 4-3-3](#) describes the system log setting object of Renewable Energy Switch.

**Enable Log**  
 **Enable Remote Log**      **Log Server IP Address:**

Auto Refresh

Figure 4-3-5: System Log Web Page Screen

Object	Description
Enable Log	Disable or enable the system log function of Renewable Energy Switch.
Enable Remote Log	Allow to send system log to remote log server.
Log Server IP Address	Allow to set IP address of remote log server.
Apply	Press this button to take effect.
Auto-Refresh <input type="checkbox"/>	Check this box to refresh the page automatically. Automatic refresh

Object	Description
	occurs every 3 seconds.
Refresh	Press this button to refresh current Web page.
Clear	Press this button to clear system log information.

Table 4-3-3: Descriptions of the System Log Objects

### 4.3.2 Operation Mode

This section provides the current operation mode, and users can set different modes to LAN and WLAN interface for NAT and bridging function on Renewable Energy Switch as the screen in [Figure 4-3-6](#) appears.

[Table 4-3-4](#) describes the Operation Mode of Renewable Energy Switch.

**Gateway :** In this mode, the device is supposed to connect to internet via ADSL/Cable Modem. The NAT is enabled and PCs in LAN ports share the same IP to ISP through WAN port. The connection type can be setup in WAN page by using PPPOE, DHCP client, PPTP client , L2TP client or static IP.

**Bridge :** In this mode, all ethernet ports and wireless interface are bridged together and NAT function is disabled. All the WAN related function and firewall are not supported.

Figure 4-3-6: Operation Mode Web Page Screen

Object	Description
Gateway	In this mode, the device enables multiusers to share Internet via ADSL/Cable Modem. The wireless port shares the same IP to ISP through Ethernet WAN port. The Wireless port acts the same as a LAN port while at AP Router mode.
Bridge	In this mode, the device can be used to combine multiple local networks together to the same one via wireless connections, especially for a home or office where separated networks can't be connected easily together with a cable.

Table 4-3-4: Descriptions of the IP Configuration Objects

### 4.3.3 Time Zone

This section assists you in setting the Renewable Energy Switch's system time. You can either select to set the time and date manually or automatically obtain the GMT time from Internet as the screen in [Figure 4-3-7](#) appears and [Table 4-3-5](#) describes the NTP Configuration object of Renewable Energy Switch.

Current Time : Yr  Mon  Day  Hr  Mn  Sec

Time Zone Select :

Enable NTP client update

Automatically Adjust Daylight Saving

NTP server :     (Manual IP Setting)

Figure 4-3-7: Time Zone Configuration Web Page Screen

Object	Description
Current Time	Allow input current time information of Renewable Energy Switch.
Copy Computer Time	Click " <b>Copy Computer Time</b> " to enter the required values automatically according to your computer's current time and date.
Time Zone Select	Allow select the time zone according to current location of Renewable Energy Switch.
Enable NTP Client Update	Allow disable or enable time update from NTP server of Renewable Energy Switch.
NTP Server	Allow choose one list NTP server or assign one NTP server IP address manually for Renewable Energy Switch.
Apply	Press this button to take effect.
Reset	Press this button to revert to previously saved values.
Refresh	Press this button to refresh the current Web page.

Table 4-3-5: Descriptions of the Time Zone Configuration Objects



### 4.3.4 User Management

This section provides the Password Setting of Renewable Energy Switch as the screen in [Figure 4-3-8](#) appears. [Table 4-3-6](#) describes the Password Setting objects of Renewable Energy Switch.


### Password Setting

<b>User Name</b>	admin
<b>Old Password</b>	
<b>New Password</b>	
<b>Confirmed Password</b>	

**Figure 4-3-8:** Password Setting Web Page Screen

Object	Description
<b>User Name</b>	Allows to input current User Name of Renewable Energy Switch.
<b>Old Password</b>	Allows to input current Password of Renewable Energy Switch.
<b>New Password</b>	Allows to input new Password of Renewable Energy Switch.
<b>Confirmed Password</b>	Allows to input new Password again for confirmation of Renewable Energy Switch.
<b>Apply</b>	Press this button to take effect.
<b>Reset</b>	Press this button to reset password setting to default mode.

**Table 4-3-6:** Descriptions of the Password Setting Objects

 Note	<ol style="list-style-type: none"> <li>1. For security reason, please change and memorize the new password after this first setup.</li> <li>2. The maximum length is 15 characters.</li> </ol>
---	--

### 4.3.5 SNMP

This section provides SNMP setting of Renewable Energy Switch as the screen in [Figure 4-3-9](#) appears and [Table 4-3-7](#) describes the SNMP object of Renewable Energy Switch.

## SNMP Management

System Community	
SNMP Agent	Disable ▾
SNMP Read Community	public
SNMP Write Community	private
System Option	
System Name	BSP-360
System Location	PLANET
Contact	Support@planet.com.tw
Description	PLANET Renewable Energy Managed
SNMP Trap Receiver Configuration	
SNMP Trap	Disable ▾
SNMP Trap Destination	192.168.0.99

Figure 4-3-9: SNMP Web Page Screen

Object	Description
SNMP Agent	Disable or enable the SNMP Agent function of Renewable Energy Switch.
SNMP Read Community	Allow to input characters for SNMP Read Community of Renewable Energy Switch. The maximum length is 30 characters.
SNMP Write Community	Allows to input characters for SNMP Write Community of Renewable Energy Switch. The maximum length is 30 characters.
System Name	Allows to input characters for System Name of Renewable Energy Switch. The maximum length is 30 characters.
System Location	Allows to input characters for System Location of Renewable Energy Switch. The maximum length is 30 characters.
Contact	Allows to input characters for contact of Renewable Energy Switch. The maximum length is 30 characters.
Description	Allows to input characters for description of Renewable Energy Switch. The maximum length is 30 characters.
SNMP Trap	Allows to enable or disable SNMP Trap function.

---

<b>Object</b>	<b>Description</b>
<b>SNMP Trap Destination</b>	Allows to send SNMP trap to an assigned workstation.

---

**Table 4-3-7:** Descriptions of the SNMP Objects

## 4.4 TCP/IP

The TCP/IP function provides WAN, LAN and network configuration of Renewable Energy Switch as [Figure 4-4-1](#) is shown below:



Figure 4-4-1: TCP/IP Function Menu

The page includes the following information:

Object	Description
WAN	Allow to set WAN interface. <a href="#">Explained in section 4.4.1.</a>
LAN	Allow to set LAN interface. <a href="#">Explained in section 4.4.2.</a>
Server	Allow to set Port Forwarding and DMZ. <a href="#">Explained in section 4.4.3.</a>
Security	Allow to set firewall and access filtering. <a href="#">Explained in section 4.4.4.</a>
Route	Allow to set Route interface. <a href="#">Explained in section 4.4.5.</a>
QoS	Allow to set QoS (Quality of Service). <a href="#">Explained in section 4.4.6.</a>

### 4.4.1 WAN

You can configure WAN connection type manually and set advanced functions like **DDNS (Dynamic DNS)** here as [Figure 4-4-2](#) is shown below:

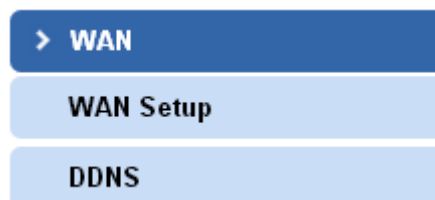


Figure 4-4-2: WAN Interface Menu

### 4.4.1.1 WAN Setup

This page is used to configure the parameters for Internet network which connects to the WAN port of Renewable Energy Switch as the screen in [Figure 4-4-3](#) appears. [Table 4-4-1](#) describes the WAN Objects Screen of Renewable Energy Switch. Here you may change the access method to **static IP**, **DHCP**, **PPPoE**, **PPTP** or **L2TP** by click the item value of WAN Access type.

**WAN Access Type:**

**IP Address:**

**Subnet Mask:**

**Default Gateway:**

**MTU Size:**  (1400-1500 bytes)

**DNS 1:**

**DNS 2:**

**DNS 3:**

**Enable uPNP**  
 **Enable IGMP Proxy**  
 **Enable Ping Access on WAN**  
 **Enable Web Server Access on WAN**  
 **Enable IPsec pass through on VPN connection**  
 **Enable PPTP pass through on VPN connection**  
 **Enable L2TP pass through on VPN connection**  
 **Enable IPv6 pass through on VPN connection**


Figure 4-4-3: WAN Interface Setup Web Page Screen


Object	Description
<b>WAN Access Type</b>	Please select the corresponding WAN Access Type for the Internet, and fill the correct parameters from your local ISP in the fields which appear below.
	<p>Select Static IP Address if all the Internet port's IP information is provided to you by your ISP (Internet Service Provider). You will need to enter the IP address, subnet mask, gateway address, and DNS address provided to you by your ISP.</p> <p>Each IP address entered in the fields must be in the appropriate IP form, which are four octets separated by a</p>

Object	Description
	<p>dot (x.x.x.x). The Router will not accept the IP address if it is not in this format.</p> <p><b>IP Address</b> Enter the IP address assigned by your ISP.</p> <p><b>Subnet Mask</b> Enter the Subnet Mask assigned by your ISP.</p> <p><b>Default Gateway</b> Enter the Gateway assigned by your ISP.</p> <p><b>DNS</b> The DNS server information will be supplied by your ISP.</p>
<b>DHCP Client</b>	Select DHCP Client to obtain IP Address information automatically from your ISP.
<b>PPPoE</b>	<p>Choose PPPoE (Point to Point Protocol over Ethernet) if your ISP uses a PPPoE connection. Your ISP will provide you with a username and password. This option is typically used for DSL services.</p> <p><b>User Name</b> Enter your PPPoE user name.</p> <p><b>Password</b> Enter your PPPoE password.</p>
<b>PPTP</b>	<p>Choose PPTP (Point-to-Point-Tunneling Protocol) if your ISP uses a PPTP connection. Your ISP will provide you with IP information and PPTP Server IP Address; of course, it also includes a username and password. This mode is typically used for DSL services.</p> <p><b>IP Address</b> Enter the IP address.</p> <p><b>Subnet Mask</b> Enter the Subnet Mask.</p> <p><b>Server IP Address</b> Enter the PPTP Server IP address provided by your ISP.</p> <p><b>User Name</b> Enter your PPTP user name.</p> <p><b>Password</b> Enter your PPTP password.</p>
<b>L2TP</b>	Choose L2TP (Layer 2 Tunneling Protocol) if your ISP uses a L2TP connection. Your ISP will provide you with a username and password.

Object	Description
	<p><b>IP Address</b> Enter the IP address.</p> <p><b>Subnet Mask</b> Enter the Subnet Mask.</p> <p><b>Server IP Address</b> Enter the L2TP Server IP address provided by your ISP.</p> <p><b>User Name</b> Enter your L2TP user name.</p> <p><b>Password</b> Enter your L2TP password.</p>
<b>Host Name</b>	This option specifies the Host Name of the Renewable Energy Switch.
<b>MTU Size</b>	The normal <b>MTU</b> (Maximum Transmission Unit) value for most Ethernet networks is 1492 Bytes. It is not recommended that you change the default <b>MTU Size</b> unless required by your ISP.
<b>Attain DNS Automatically</b>	Select " <b>Attain DNS Automatically</b> ", the DNS servers will be assigned dynamically from your ISP.
<b>Set DNS Manually</b>	If your ISP gives you one or two DNS addresses, select <b>Set DNS Manually</b> and enter the primary and secondary addresses into the correct fields.
<b>Enable uPnP</b>	Check the box to enable the uPnP function.
<b>Enable IGMP Proxy</b>	Check the box to enable the IGMP Proxy function.
<b>Enable Ping Access on WAN</b>	Check the box to enable Ping access from the Internet Network.
<b>Enable Web Server Access on WAN</b>	Check the box to enable the web server access of the Renewable Energy Switch from the Internet network.
<b>Enable IPSec pass through on VPN connection</b>	Check the box to enable IPSec pass through function on VPN connection.
<b>Enable PPTP pass through on VPN connection</b>	Check the box to enable PPTP pass through function on VPN connection.
<b>Enable L2TP pass through on VPN connection</b>	Check the box to enable L2TP pass through function on VPN connection.
<b>Enable IPv6 pass through on VPN connection</b>	Check the box to enable IPv6 pass through function on VPN connection.

Table 4-4-2: Descriptions of the WAN Objects

 Note  
If you get Address not found error when you access a Web site, it is likely that your DNS servers are set up improperly. You should contact your ISP to get DNS server addresses.

 Note  
WAN IP, whether obtained automatically or specified manually, should NOT be on the same IP net segment as the LAN IP; otherwise, the router will not work properly. In case of emergency, press the hardware "Reset" button.

#### 4.4.1.2 DDNS

The Renewable Energy Switch offers the **DDNS** (Dynamic Domain Name System) feature as the screen in [Figure 4-4-4](#) appears, which allows the hosting of a website, FTP server, or e-mail server with a fixed domain name (named by yourself) and a dynamic IP address, and then your friends can connect to your server by entering your domain name no matter what your IP address is. [Table 4-4-2](#) describes the DDNS Objects Screen of Renewable Energy Switch.

**Enable DDNS**

**Service Provider :**

**Domain Name :**

**User Name/Email :**

**Password/Key :**

*Note:*

*For TZO, you can have a 30 days free trial [here](#) or manage your TZO account in [control panel](#)  
For DynDNS, you can create your DynDNS account [here](#)*

Figure 4-4-4: DDNS Interface Setup Web Page Screen

Object	Description
Enable DDNS	Check the box to enable the Dynamic DNS function.
Service Provider	Select the DDNS service provider from the drop-down menu, such as DynDNS or TZO.
Domain Name	Enter the domain name you have registered from the DDNS service provider.
User Name/Email	Enter the user name or email you have registered from the DDNS service provider.
Password/Key	Enter the password you have registered from the DDNS service provider.

Table 4-4-2: Descriptions of the DDNS Objects



## 4.4.2 LAN

You can configure LAN connection type manually here and see the LAN Statistics here as [Figure 4-4-5](#) is shown below:

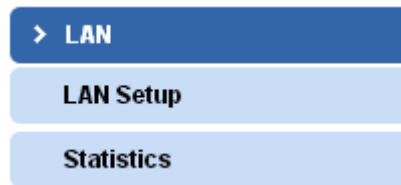


Figure 4-4-5: LAN Interface Menu

### 4.4.2.1 LAN Setup

This page is used to configure the parameters for local area network which connects to the LAN port of your Access Point as the screen in [Figure 4-4-6](#) appears. [Table 4-4-3](#) describes the LAN Objects Screen of Renewable Energy Switch. Here you may change the setting for IP address, subnet mask, DHCP, etc...


IP Address :	<input type="text" value="192.168.0.100"/>
Subnet Mask :	<input type="text" value="255.255.255.0"/>
Default Gateway :	<input type="text" value="192.168.0.254"/>
DHCP :	<input type="text" value="Disabled"/>
DHCP Client Range :	<input type="text" value="192.168.0.101"/> - <input type="text" value="192.168.0.200"/> <input type="button" value="Show Client"/>
DHCP Lease Time :	<input type="text" value="480"/> (1 ~ 10080 minutes)
Static DHCP :	<input type="button" value="Set Static DHCP"/>
Domain Name :	<input type="text" value="Planet"/>
802.1d Spanning Tree :	<input type="text" value="Disabled"/>

Figure 4-4-6: LAN Interface Setup Web Page Screen

Object	Description
IP Address	The LAN IP address of the Renewable Energy Switch and default is <b>192.168.0.100</b> . You can change it according to your request.
Subnet Mask	Default is <b>255.255.255.0</b> . You can change it according to your request.
Default Gateway	Default is <b>192.168.0.254</b> . You can change it according to your request.
DHCP	You can select one of <b>Disable, Client, and Server</b> . Default is <b>Server</b> , that the Renewable Energy Switch can assign IP addresses to the computers automatically.
DHCP Client Range	For the <b>Server</b> mode, you must enter the DHCP client IP address range in the field. And you can click the " <b>Show Client</b> " button to show the Active DHCP Client Table.

Object	Description
Domain Name	Default is Planet.
802.1d Spanning Tree	You can enable or disable the spanning tree function.

Table 4-4-3: Descriptions of the DDNS Objects



If you change the device's LAN IP address, you must enter the new one in your browser to get back to the web-based configuration utility. And LAN PCs' gateway must be set to this new IP for successful Internet connection.

#### 4.4.2.2 Statistics

This page shows the packet counters for transmission and reception regarding to Ethernet network as the screen in [Figure 4-4-7](#) appears. [Table 4-4-4](#) describes the Statistics Objects Screen of Renewable Energy Switch.

Interface	Receive	Transmit
Port 1	457.28 KBytes	1.32 MBytes
Port 2	0 Bytes	0 Bytes
Port 3	0 Bytes	0 Bytes
Port 4	457.28 KBytes	1.32 MBytes
Port 5	0 Bytes	0 Bytes

Refresh

Figure 4-4-7: Statistics Web Page Screen

Object	Description
Transmit	It shows the statistic count of sent packets on the Ethernet LAN interface.
Receive	It shows the statistic count of received packets on the Ethernet LAN interface.
Refresh	Click the refresh the statistic counters on the screen.

Table 4-4-4: Descriptions of the Statistics Objects

### 4.4.3 Server

You can configure Port Forwarding and DMZ here as [Figure 4-4-8](#) is shown below:



Figure 4-4-8: Server Setup Menu

#### 4.4.3.1 Port Forwarding

Entries in this table allow you to automatically redirect common network services to a specific machine behind the NAT firewall as the screen in [Figure 4-4-9](#) appears. [Table 4-4-5](#) describes the Port Forwarding Objects Screen of Renewable Energy Switch. These settings are only necessary if you wish to host some sort of server like a web server or mail server on the private local network behind your Gateway's NAT firewall.

Choose menu “**Service Setup → Port Forwarding**”, and you can configure to re-direct a particular range of service port numbers from the Internet network to a particular LAN IP address. It helps users to host some servers behind the firewall. After the configuration, please click the “Apply” button to save the settings.

**Enable Port Forwarding**

IP Address :

Protocol :

Port Range :  -

Comment :

#### Current Port Forwarding Table :

Local IP Address	Protocol	Port Range	Comment	Select
192.168.0.101	TCP+UDP	8080	Test	<input type="checkbox"/>
192.168.0.102	TCP	8088	Web server	<input type="checkbox"/>

Figure 4-4-9 Port Forwarding Setup Web Page Screen

Object	Description
Enable Port Forwarding	Enable Port Forwarding function
IP Address	Add <b>LAN IP address</b> of specified host or server on the private local network.

Object	Description
Protocol	Select the port number protocol type (TCP, UDP or both). If you are unsure, then leave it to the default both protocols.
Port Range	Add ports you want to control. For TCP and UDP Services, enter the beginning of the range of port numbers used by the service. If the service uses a single port number, enter it in both the start and finish fields.
Comment	The description of this setting.

Table 4-4-5: Descriptions of the Port Forwarding Objects

#### 4.4.3.2 DMZ

A Demilitarized Zone is used to provide Internet services without sacrificing unauthorized access to its local private network as the screen in [Figure 4-4-10](#) appears. [Table 4-4-6](#) describes the DMZ Objects Screen of Renewable Energy Switch. Typically, the DMZ host contains devices accessible to Internet traffic, such as Web (HTTP) servers, FTP servers, SMTP (e-mail) servers and DNS servers.

Choose menu “**Service Setup → DMZ**”, and you can configure the private IP address of DMZ. The DMZ feature allows one local host to be exposed to the Internet for a special-purpose service such as Internet gaming or video conferencing. After the configuration, please click the “Apply” button to save the settings.

**Enable DMZ**

DMZ Host IP Address:

Figure 4-4-10 DMZ Setup Web Page Screen

Object	Description
Enable DMZ	Check the box to enable DMZ function. If the DMZ Host Function is enabled, it means that you set up DMZ host at a particular computer to be exposed to the Internet so that some applications/software, especially Internet / online game can have two way connections.
DMZ Host IP Address	Enter the IP address of a particular host in your LAN which will receive all the packets originally going to the WAN port / Public IP address above.

Table 4-4-6: Descriptions of the DMZ Objects

## 4.4.4 Security

The Security Setup contains submenus of the settings about firewall and access filtering. Please refer to the following sections for the details as [Figure 4-4-11](#) is shown below:

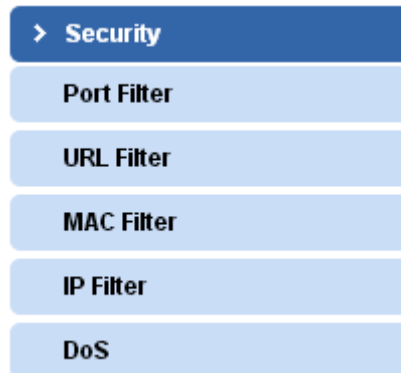


Figure 4-4-11: Security Setup Menu

### 4.4.4.1 Port Filtering

Entries in this table are used to restrict certain types of data packets from your local network to Internet through the Gateway. Use of such filters can be helpful in securing or restricting your local network as the screen in [Figure 4-4-12](#) appears. [Table 4-4-7](#) describes the Port Filtering Objects Screen of Renewable Energy Switch.

Choose menu “**Security Setup → Port Filter**”, and you can configure which port range and protocol to be restricted. After the configuration, please click the “**Apply**” button to save the settings.

**Enable Port Filtering**

**Port Range:**  -

**Protocol:**

**Comment:**

**Current Filter Table:**

Port Range	Protocol	Comment	Select
1000-2000	TCP+UDP	Test	<input type="checkbox"/>

Figure 4-4-12 Port Filtering Setup Web Page Screen

Object	Description
Enable Port Filtering	Enable Port Filtering function.

Object	Description
Port Range	Add ports you want to control.
Protocol	Select the port number protocol type (TCP, UDP or both). If you are unsure, then leave it to the default both protocols.
Comment	The description of this setting.

Table 4-4-7: Descriptions of the Port Filtering Objects

#### 4.4.4.2 URL Filtering

URL filter is used to deny LAN users from accessing the internet as the screen in [Figure 4-4-13](#) appears. Block those URLs which contain keywords listed below. [Table 4-4-8](#) describes the URL Filtering Objects Screen of Renewable Energy Switch.

Choose menu “**Security Setup → URL Filtering**”, and you can configure which URL addresses to be blocked. After the configuration, please click the “Apply” button to save the settings.

**Enable URL Filtering**

URL Address :

**Current Filter Table:**

URL Address	Select
sex	<input type="checkbox"/>

Figure 4-4-13 URL Filtering Setup Web Page Screen

Object	Description
Enable URL Filtering	Check this box to enable URL Filter function.
IP Address	The IP Address that you want to filter.
URL Address	The URL Address that you want to filter.

Table 4-4-8: Descriptions of the URL Filtering Objects



If you wish to block www.facebook.com, simply type in "facebook" and the Renewable Energy Switch will block all websites with the text "facebook" in the URL.

### 4.4.4.3 MAC Filtering

Entries in this table are used to restrict certain types of data packets from your local network to Internet through the Renewable Energy Switch. Use of such filters can be helpful in securing or restricting your local network as the screen in [Figure 4-4-14](#) appears. [Table 4-4-9](#) describes the MAC Filtering Objects Screen of Renewable Energy Switch.

Choose menu “**Security Setup**→ **MAC Filter**”, and you can configure which computer of the specified MAC address to be restricted. After the configuration, please click the “Apply” button to save the settings.

**Enable MAC Filtering**

**MAC Address :**

**Comment :**

**Current Filter Table:**

MAC Address	Comment	Select
00:30:4f:aa:bb:cc	test	<input type="checkbox"/>

Figure 4-4-14 MAC Filtering Setup Web Page Screen

Object	Description
Enable MAC Filtering	Enable MAC filtering.
MAC Address	Add MAC address you want to control.
Comment	The description of this setting.

Table 4-4-9: Descriptions of the MAC Filtering Objects

#### 4.4.4.4 IP Filtering

IP Filtering is used to block internet or network access to **specific IP addresses** on your local network as the screen in [Figure 4-4-15](#) appears. The restricted user may still be able to login to the network but will not be able to access the internet. To begin blocking access to an IP address, enable IP Filtering and enter the IP address of the user you wish to block. [Table 4-4-10](#) describes the IP Filtering Objects Screen of Renewable Energy Switch.

Choose menu “**Security Setup → IP Filter**”, and you can configure which IP address and protocol to be restricted. After the configuration, please click the “**Apply**” button to save the settings.

**Enable IP Filtering**

**Local IP Address :**

**Protocol:**

**Comment :**

**Current Filter Table:**

Local IP Address	Protocol	Comment	Select
192.168.0.101	TCP+UDP	Test	<input type="checkbox"/>

Figure 4-4-15 IP Filtering Setup Web Page Screen

Object	Description
Enable IP Filtering	Check this box to enable IP Filter function
Local IP Address	Add LAN IP address you want to control
Protocol	Select the port number protocol type ( <b>TCP</b> , <b>UDP</b> or <b>both</b> ). If you are unsure, then leave it to the default <b>both</b> protocol
Comment	The description of this setting

Table 4-4-10: Descriptions of the IP Filtering Objects



#### 4.4.4.5 Denial of Service (DoS)

The Renewable Energy Switch can prevent specific DoS attacks from entering your network as the screen in [Figure 4-4-16](#) appears. A "Denial-of-Service" (DoS) attack is characterized by an explicit attempt by hackers to prevent legitimate users of a service from using that service. [Table 4-4-11](#) describes the IP Filtering Objects Screen of Renewable Energy Switch.

Choose menu "Security Setup → DoS" to configure the settings of DoS attack prevention. After the configuration, please click the "Apply" button to save the settings.

### Denial of Service

**Enable DoS Prevention**

<input type="checkbox"/> <b>Whole System Flood: SYN</b>	<input type="text" value="0"/>	Packets/Second
<input type="checkbox"/> <b>Whole System Flood: FIN</b>	<input type="text" value="0"/>	Packets/Second
<input type="checkbox"/> <b>Whole System Flood: UDP</b>	<input type="text" value="0"/>	Packets/Second
<input type="checkbox"/> <b>Whole System Flood: ICMP</b>	<input type="text" value="0"/>	Packets/Second
<input type="checkbox"/> <b>Per-Source IP Flood: SYN</b>	<input type="text" value="0"/>	Packets/Second
<input type="checkbox"/> <b>Per-Source IP Flood: FIN</b>	<input type="text" value="0"/>	Packets/Second
<input type="checkbox"/> <b>Per-Source IP Flood: UDP</b>	<input type="text" value="0"/>	Packets/Second
<input type="checkbox"/> <b>Per-Source IP Flood: ICMP</b>	<input type="text" value="0"/>	Packets/Second
<input type="checkbox"/> <b>TCP/UDP PortScan</b>	Low ▼	Sensitivity
<input type="checkbox"/> <b>ICMP Smurf</b>		
<input type="checkbox"/> <b>IP Land</b>		
<input type="checkbox"/> <b>IP Spoof</b>		
<input type="checkbox"/> <b>IP TearDrop</b>		
<input type="checkbox"/> <b>PingOfDeath</b>		
<input type="checkbox"/> <b>TCP Scan</b>		
<input type="checkbox"/> <b>TCP SynWithData</b>		
<input type="checkbox"/> <b>UDP Bomb</b>		
<input type="checkbox"/> <b>UDP EchoChargen</b>		

**Enable Source IP Blocking**  Block time (sec)

Figure 4-4-16 DOS Setup Web Page Screen

Object	Description
Enable DoS Prevention	Check to enable DoS function. User may set other related configurations about DoS below.

Table 4-4-11: Descriptions of the DOS Objects

## 4.4.5 Route

There are two route types that are Dynamic Route and Static Route. Please refer to the following sections for the details as [Figure 4-4-17](#) is shown below:

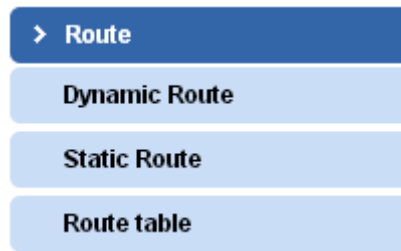


Figure 4-4-17: Route Setup Menu

### 4.4.5.1 Dynamic Route

Dynamic routing is a networking technique that provides optimal data routing as the screen in [Figure 4-4-18](#) appears. Unlike static routing, dynamic routing enables routers to select paths according to real-time logical network layout changes. [Table 4-4-12](#) describes the Dynamic Route Objects Screen of Renewable Energy Switch.

Enable Dynamic Route

NAT :  Disabled  Enabled

Transmit :  Disabled  RIP 1  RIP 2

Receive:  Disabled  RIP 1  RIP 2

Figure 4-4-18 Dynamic Route Setup Web Page Screen

Object	Description
Enable Dynamic Route	Click this box to enable Dynamic Route.

Table 4-4-12: Descriptions of the Dynamic Route Objects

### 4.4.5.2 Static Route

Static routing is a special type of routing that can be applied in a network to reduce the problem of routing selection and data flow overload caused by routing selection so as to improve the packets forwarding speed. You can set the destination IP address, subnet mask, and gateway to specify a routing rule as the screen in

Figure 4-4-19 appears. The destination IP address and subnet mask determine a destination network or host to which the router sends packets through the gateway. Table 4-4-13 describes the Dynamic Route Objects Screen of Renewable Energy Switch.

**Enable Static Route**

**IP Address:**

**Subnet Mask:**

**Gateway:**

**Metric:**

**Interface:**

**Current Filter Table :**

Destination IP Address	Netmask	Gateway	Metric	Interface	Select
<input type="button" value="Delete Selected"/> <input type="button" value="Delete All"/> <input type="button" value="Reset"/>					

Figure 4-4-19 Static Route Setup Web Page Screen

Object	Description
<b>Enable Static Route</b>	Click this box to enable static route.
<b>IP Address</b>	The network or host IP address desired to access.
<b>Subnet Mask</b>	The subnet mask of destination IP.
<b>Gateway</b>	The gateway is the router or host's IP address to which packet was sent. It must be the same network segment with the WAN or LAN port.

Table 4-4-13: Descriptions of the Static Route Objects

### 4.4.5.3 Route table

Choose menu “**Routing Table**”, and you can check all of the valid route entries in use as the screen in [Figure 4-4-20](#) appears. The Destination IP address, Gateway, Genmask, Interface and Type will be displayed for each entry. Click the **Refresh** button to refresh the data displayed.

## Routing Table

Destination	Gateway	Genmask	Metric	Interface	Type
192.168.1.0	0.0.0.0	255.255.255.0	0	WAN	Dynamic
192.168.0.0	0.0.0.0	255.255.255.0	0	LAN	Dynamic
127.0.0.0	0.0.0.0	255.0.0.0	0	LAN	Dynamic
0.0.0.0	192.168.1.254	0.0.0.0	0	WAN	Dynamic
0.0.0.0	192.168.0.254	0.0.0.0	0	LAN	Dynamic

Refresh Close

Figure 4-4-20 Route table Web Page Screen

### 4.4.6 QoS (Quality of Service)

The **QoS (Quality of Service)** helps improve your network gaming performance by prioritizing applications as the screen in [Figure 4-4-21](#) appears. [Table 4-4-14](#) describes the QoS Objects Screen of Renewable Energy Switch. By default the bandwidth control are disabled and application priority is not classified automatically. In order to complete this settings, please follow the steps below.

- (1) Enable this function.
- (2) Enter the total speed or choose automatic mode.
- (3) Enter the IP address or MAC address user want to control.
- (4) Specify how to control this PC with this IP address or MAC address, including maximum or minimum bandwidth, priority and its up/down speed.

After the configuration, please click the “**Apply**” button to save the settings.

**Enable QoS**

**Automatic Uplink Speed**  (Kbps)

**Automatic Downlink Speed**  (Kbps)

**QoS Rule Setting :**

**Address Type:**  IP  MAC

**Local IP Address:**  -

**MAC Address:**

**Mode:**

**Uplink Bandwidth (Kbps):**

**Downlink Bandwidth (Kbps):**

**Comment:**

**Current QoS Rules Table:**

Local IP Address	MAC Address	Mode	Uplink Bandwidth	Downlink Bandwidth	Comment	Select
<input type="button" value="Delete Selected"/> <input type="button" value="Delete All"/> <input type="button" value="Reset"/>						

Figure 4-4-21 QoS Setup Web Page Screen

Object	Description
<b>Enable QoS</b>	Check the box to enable the QoS function.
<b>Automatic Uplink Speed</b>	Check the box to adjust the uplink speed automatically by the Renewable Energy Switch. Or enter the uplink data rate manually in the field below.
<b>Automatic Downlink Speed</b>	Check the box to adjust the downlink speed automatically by the Renewable Energy Switch. Or enter the downlink data rate manually in the field below.
<b>QoS Rule Setting</b>	To set the priority rule, you can appoint the computer by <b>IP</b> address or <b>MAC</b> address, and enter it in the correct field. Select <b>minimum</b> or <b>maximum</b> bandwidth, and then fill the <b>uplink</b> and <b>downlink</b> data rate into the field.

Table 4-4-14: Descriptions of the QoS Objects

## 4.5 Battery Management

The page provides for the user to configure the battery parameters so as to achieve the best application condition as the screen in [Figure 4-5-1](#) appears. [Table 4-5-1](#) describes the Battery Management Objects Screen of Renewable Energy Switch. Before the configuration operation, please contact the suppliers of your battery for the product-specific parameters.

### Battery Management

<b>Battery Type</b>	Lead-acid Battery ▾
<b>Battery Capacity</b>	14 Ah
<b>Install Time of Battery</b>	2016 8 31 Today
<b>Battery Life</b>	11 Days
<b>Float Charge Voltage</b>	26.0 V (26.0~30.0V)
<b>Absorption Charge Voltage</b>	28.0 V (28.0~32.0V)
<b>Low Voltage Disconnection</b>	22.7 V (21.0~25.0V)
<b>Low Voltage Reconnection</b>	24.0 V (23.0~27.0V)
<b>Low Voltage Cut-Off Protection</b>	OFF ▾

Apply Reset

Set Solar to Default

Figure 4-5-1 Battery Management Web Page Screen

Object	Description
<b>Battery Type</b>	Nickel-cadmium or Lead-acid battery.
<b>Battery Capacity</b>	Enter the Battery Capacity to the item. Please ask the battery vendor about this information.
<b>Install Time of Battery</b>	Enter the install time of battery to the item.
<b>Battery Life</b>	Enter the battery life to the item. Please ask the battery vendor about this information.
<b>Float Charge Voltage</b>	<b>DC 27.2V ( 26.0~30.0V)</b> When the battery charge completes the charging process, its voltage will drop to a float charge voltage and maintain at this voltage with a minimal charging current for supplemental battery charging.
<b>Absorption Charge Voltage</b>	<b>DC 29.2V (28.0~32.0V)</b> When the battery voltage achieves the value of absorption charge voltage, the controller will maintain this voltage and charge for a period of time which will not cause excessive charging of the battery.
<b>Low Voltage Disconnection</b>	<b>DC 22.2V (21.0~25.0V)</b>

Object	Description	
	When the battery voltage is less than the value for low-voltage disconnection, the controller will not supply to the load so as to protect the battery from over-discharge.	
<b>Low Voltage Reconnection</b>	<p><b>DC 24.8V (23.0~27.0V)</b></p> When the battery is under the condition of low voltage disconnection, if the battery voltage is recovered and higher than the value for low voltage reconnection, the low-voltage circuit disconnection will be lifted and the connection is restored.	
<b>Low Voltage Cut-Off Protection</b>	Off	Disable this function.
	Log & Trap	When the battery capacity is lower than 20% that send log and SNMP trap to server.
	Log & Trap & Cut	When the battery capacity is lower than 20% that send log and SNMP trap to server, and power off the low priority port.
<b>Set Solar to Default</b>	Press this button to reset <b>FCV</b> , <b>ACV</b> , <b>LVD</b> and <b>LVR</b> setting to default value.	
<b>Reset</b>	Press this button to revert to previously saved values.	
<b>Apply</b>	Press this button to take effect.	

Table 4-5-1: Descriptions of the Battery Management Objects

### Low Voltage Disconnection / Low Voltage Reconnection

When the battery voltage is lower than the value for the low-voltage disconnection (LVD), the controller will stop supplying power to the load. It requires the charging from the PV panel so as to increase the battery voltage to be above the value for low-voltage reconnection (LVR) and thus the PoE device can be recovered as the screen in [Figure 4-5-2](#) appears.

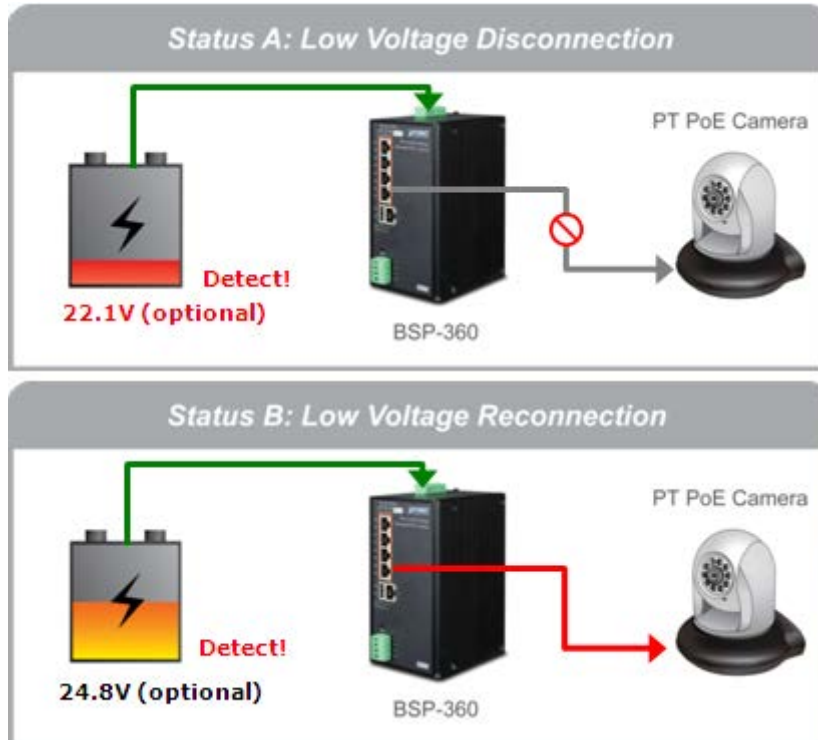


Figure 4-5-2 Low Voltage Disconnection / Low Voltage Reconnection



### Low Voltage Cut-Off Protection

If the power is too low to empower the system and IP devices, the system will automatically power off the device with low priority to make sure the system works normally, and an alert is then sent to the administrator at the same time as the screen in [Figure 4-5-3](#) appears.

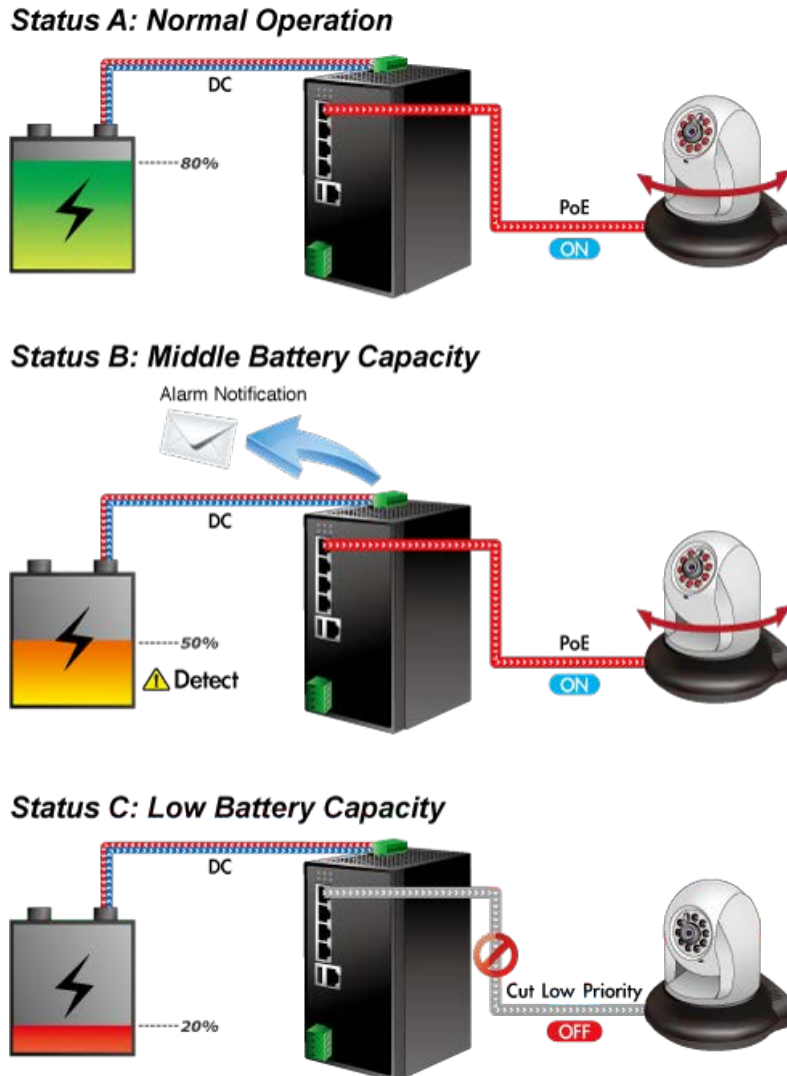
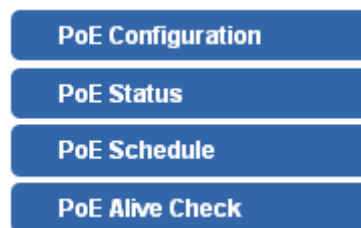


Figure 4-5-3 Low Voltage Cut-Off Protection

## 4.6 PoE Management

The PSU input power consumption is monitored by measuring voltage and current. The input power consumption is equal to the system's aggregated power consumption. The power management concept allows all ports to be active and activates additional ports, as long as the aggregated power of the system is lower than the power level at which additional PDs cannot be connected. When this value is exceeded, ports will be deactivated, according to user-defined priorities. The power budget is managed according to the following user-definable parameters: maximum available power, ports priority and maximum allowable power per port.

The Power over Ethernet provides PoE Configuration and PoE Schedule as shown in [Figure 4-6-1](#).



**Figure 4-6-1:** Power over Ethernet Function Menu

The page includes the following information:

Object	Description
PoE Configuration	Allow to centralize management PoE power for PDs. <a href="#">Explained in section 4.6.1.</a>
PoE Status	Display the current PoE usage. <a href="#">Explained in section 4.6.2.</a>
PoE Schedule	Allow to centralize management PoE power for providing schedule. <a href="#">Explained in section 4.6.3.</a>
PD Alive Check	Allow to centralize management PoE power for checking PDs alive. <a href="#">Explained in section 4.6.4.</a>

## 4.6.1 PoE Configuration

This section provides PoE (Power over Ethernet) Configuration and PoE output status of Renewable Energy Switch as screen in Figure 4-6-2 appears. Table 4-6-1 describes the PoE Configuration object of Renewable Energy Switch.

System PoE Admin Mode	Enable ▾
Power Supply	52 V
Power Limit Mode	Consumption ▾
PoE Temperature	49°C / 120°F

Power Allocation 0%  0 / 120 W

Port	Description	PoE Function	Schedule	Power Mode	Priority	Device Class	Current Used [mA]	Powered Used [W]	Power Limit[W]
1		Enable ▾	Profile1 ▾	AF ▾	High ▾	--	0	0	36
2		Enable ▾	Profile1 ▾	AT ▾	High ▾	--	0	0	36
3		Enable ▾	Profile1 ▾	AT ▾	High ▾	--	0	0	36
4		Enable ▾	Profile1 ▾	AT ▾	High ▾	--	0	0	36
<b>Total</b>							0	0	

Apply Refresh Auto Refresh

Figure 4-6-2: PoE Configuration Web Page Screen

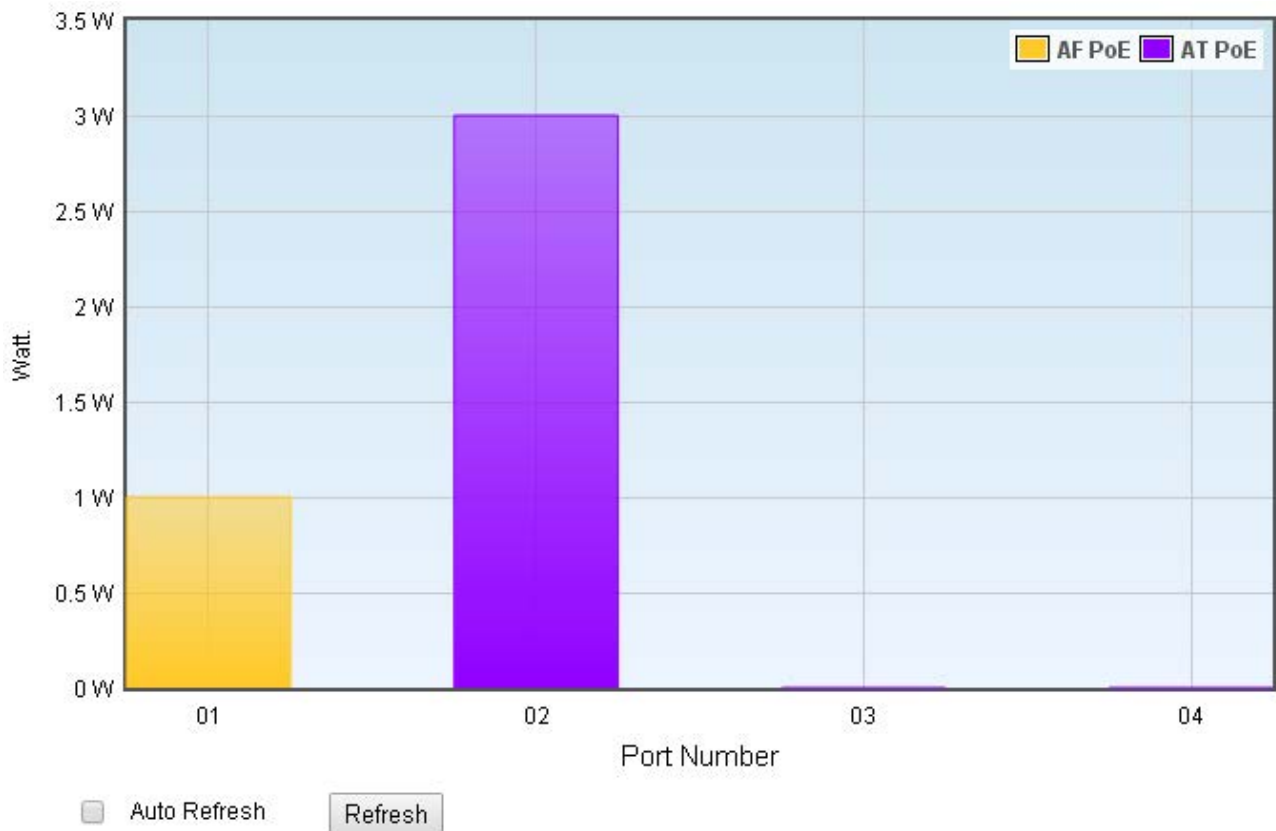
Object	Description
System PoE Admin Mode	Allows user to disable / enable PoE function.
Power Supply	Displays PoE power supply status.
Power Limit Mode	Allows user to configure power limit mode, which can be chosen. <b>Consumption:</b> Based on the real device power consumption where PoE power is delivered as system default setting is in this mode. <b>Allocation:</b> Users allow to assign how much PoE power to each port and the system will reserve PoE power to PD.
PoE Temperature	Displays the current PoE temperature of Renewable Energy Switch.
Power Allocation	Displays the current total power consumption status.
Description	This function provides input per port description and the available letters is 30. <b>NOTE:</b> The total maximum letters are only 800. Some of special words will count as 5 per word, like ‘, “, \, < and >.
PoE Function	Allows user to disable or enable per port PoE function, also allow choose schedule for enable PoE Schedule function of each port.
Schedule	Indicates the scheduled profile mode. Possible profiles are:

Object	Description
	<p><b>Profile1</b></p> <p><b>Profile2</b></p> <p><b>Profile3</b></p> <p><b>Profile4</b></p> <p>This function is available when choosing schedule on each port.</p>
<b>Power Mode</b>	<p>Allows user to select AT/AF compatibility mode. The default value is AT mode.</p> <p>Indicates the power inline mode.</p>
<b>Priority</b>	<p>The Priority represents PoE ports priority. There are three levels of power priority named <b>Low</b>, <b>High</b> and <b>Critical</b>.</p> <p>The priority is used in case the total power consumption is over the total power budget. In this case the port with the lowest priority will be turned off, and offer power for the port of higher priority.</p>
<b>Device Class</b>	<p>Displays PoE class level.</p> <p>The IEEE 802.3af standard offers PoE class level from <b>1 to 3</b> and IEEE 802.3at standard offers the class from <b>1 to 4</b>.</p>
<b>Current Used [mA]</b>	<p>The <b>Power Used</b> shows how much current the PD currently is using.</p>
<b>Power Used [W]</b>	<p>The <b>Power Used</b> shows how much power the PD currently is using</p>
<b>Power Limit [W]</b>	<p>It can limit the port PoE supply watts. Per port maximum value must be less than <b>36 watts</b>. Total port values must be less than the Power Reservation value. Once power overload is detected, the port will auto shut down and keep in detection mode until PD's power consumption is lower than the power limit value.</p>
<b>Apply</b>	<p>Press this button to take effect.</p>
<b>Refresh</b>	<p>Press this button to refresh the current Web page.</p>
<b>Auto-Refresh</b> <input type="checkbox"/>	<p>Check this box to refresh the page automatically. Automatic refresh occurs every 3 seconds.</p>

Table 4-6-1: Descriptions of the PoE Configuration Objects

## 4.6.2 PoE Status

This page allows user to see the usage of individual PoE Port as the screen in [Figure 4-6-3](#) appears. [Table 4-6-2](#) describes the PoE Status Objects Screen of Renewable Energy Switch.



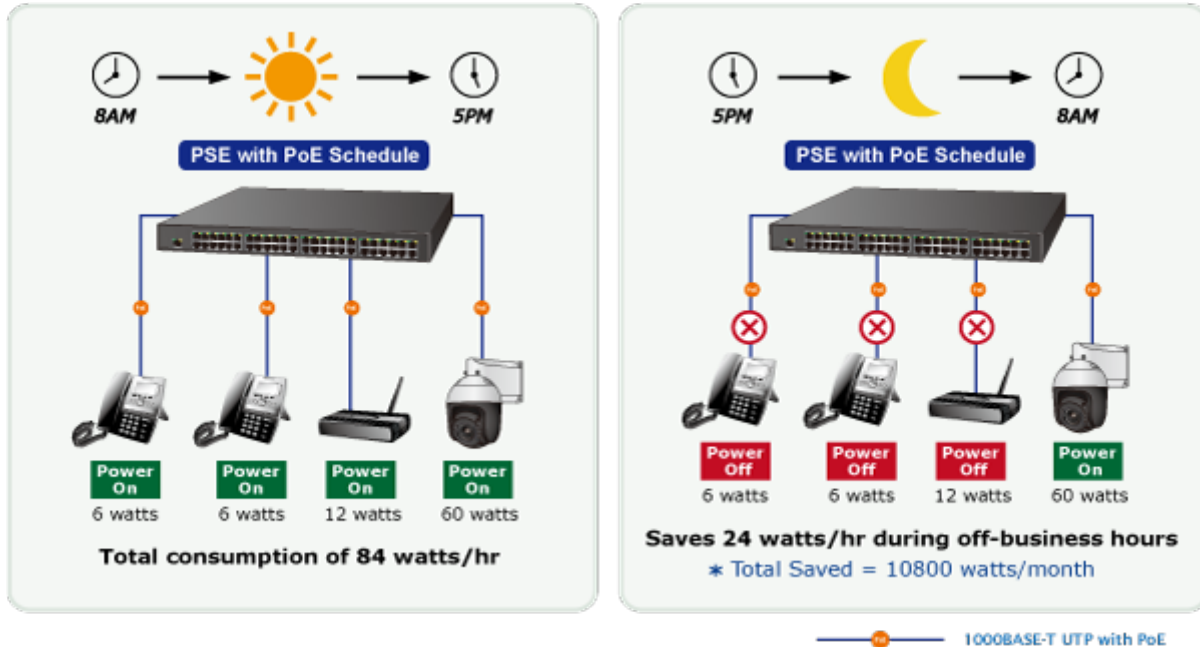
**Figure 4-6-3:** PoE Status Web Page Screen

Object	Description
<b>Port Number</b>	Displays per port status.
<b>Watt</b>	Displays per port PoE usage.
<b>AF PoE</b>	Indicates the AF PoE operation mode of that port.
<b>AT PoE</b>	Indicates the AT PoE operation mode of that port.
<b>Refresh</b>	Press this button to refresh the current Web page.
<b>Auto Refresh</b>	Check this box to refresh the page automatically. Automatic refresh occurs every 3 seconds.

**Table 4-6-2:** Descriptions of the PoE Status Objects

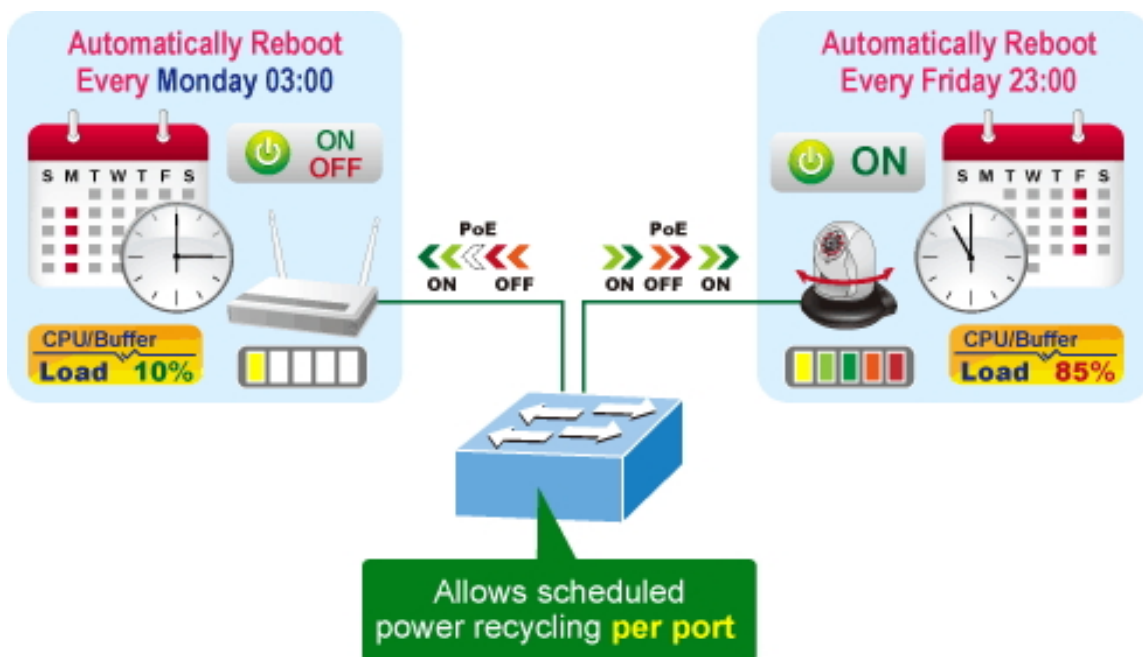
### 4.6.3 PoE Schedule

This section provides user to configure PoE schedule and scheduled power recycling. The “PoE schedule” helps you to enable or disable PoE power feeding for PoE ports during specified time intervals and it is a powerful function to help SMBs or enterprises save power and money.



### Scheduled Power Recycling

The Ultra PoE Managed Injector Hub allows each of the connected PoE IP cameras to reboot at a specified time each week. Therefore, it will reduce the chance of IP camera crash resulting from buffer overflow.



The PoE Schedule Profile Web Screens are shown in [Figure 4-6-4](#) and [Table 4-6-3](#).

Port	Description	PoE Function	Schedule	Power Mode	Priority	Device Class	Current Used [mA]	Powered Used [W]	Power Limit[W]
1		Schedule ▾	Profile1 ▾	AF ▾	High ▾	0	3.78	1	36
2		Schedule ▾	Profile2 ▾	AT ▾	High ▾	0	25.51	1	36
3		Schedule ▾	Profile3 ▾	AT ▾	High ▾	--	0	0	36
4		Schedule ▾	Profile4 ▾	AT ▾	High ▾	--	0	0	36
<b>Total</b>							29	2	

Figure 4-6-4: PoE Configuration Web Page Screen


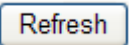
Object	Description
<b>PoE Function</b>	Allows user to disable or enable per port PoE function, also allow choose schedule for enable PoE Schedule function of each port.
<b>Schedule</b>	Indicates the scheduled profile mode. Possible profiles are: <b>Profile1</b> <b>Profile2</b> <b>Profile3</b> <b>Profile4</b> This function available when choose schedule on each port.
 button	Saves the current configuration.
 button	Refreshes the Web page and the current configuration if user doesn't save it.
<b>Auto-Refresh</b> <input type="checkbox"/>	Check this box to refresh the page automatically. Automatic refresh occurs every 3 seconds.

Table 4-6-3: Descriptions of the per port PoE Schedule Profile Objects

PoE Schedule user can configure a duration time for PoE port as default value does not provide power; screen in Figure 4-6-5 and Table 4-6-4 show.

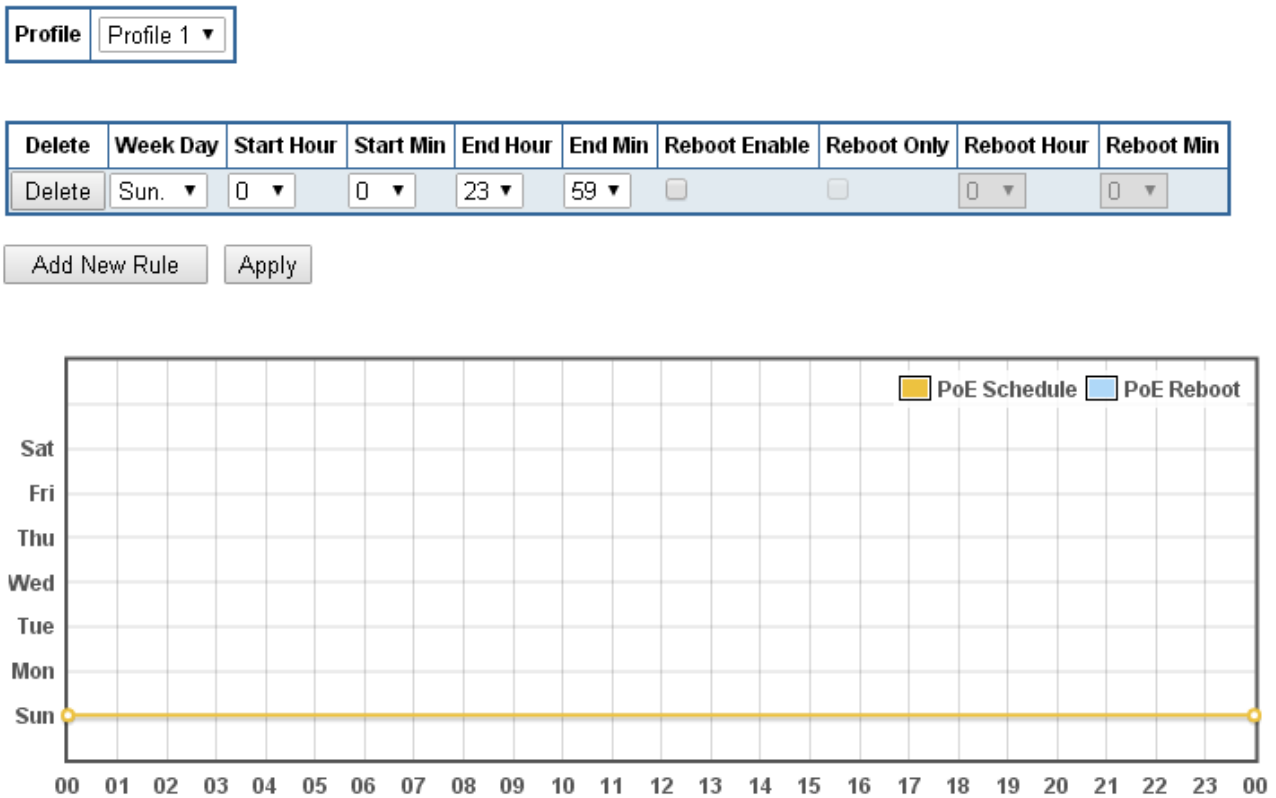


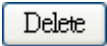


Figure 4-6-5: PoE Schedule Web Page Screen

Object	Description
Profile	Set the schedule profile mode. Possible profiles are: <b>Profile1</b> <b>Profile2</b> <b>Profile3</b> <b>Profile4</b>
Delete	Check to delete the entry.
Week Day	Allows user to set week day for defining PoE function by enabling it on the day. <b>Sun.:</b> Sunday <b>Mon.:</b> Monday <b>Tue.:</b> Tuesday <b>Wed.:</b> Wednesday <b>Thu.:</b> Thursday <b>Fri.:</b> Friday <b>Sat.:</b> Saturday
Start Hour	Allows user to set what hour PoE function does by enabling it.

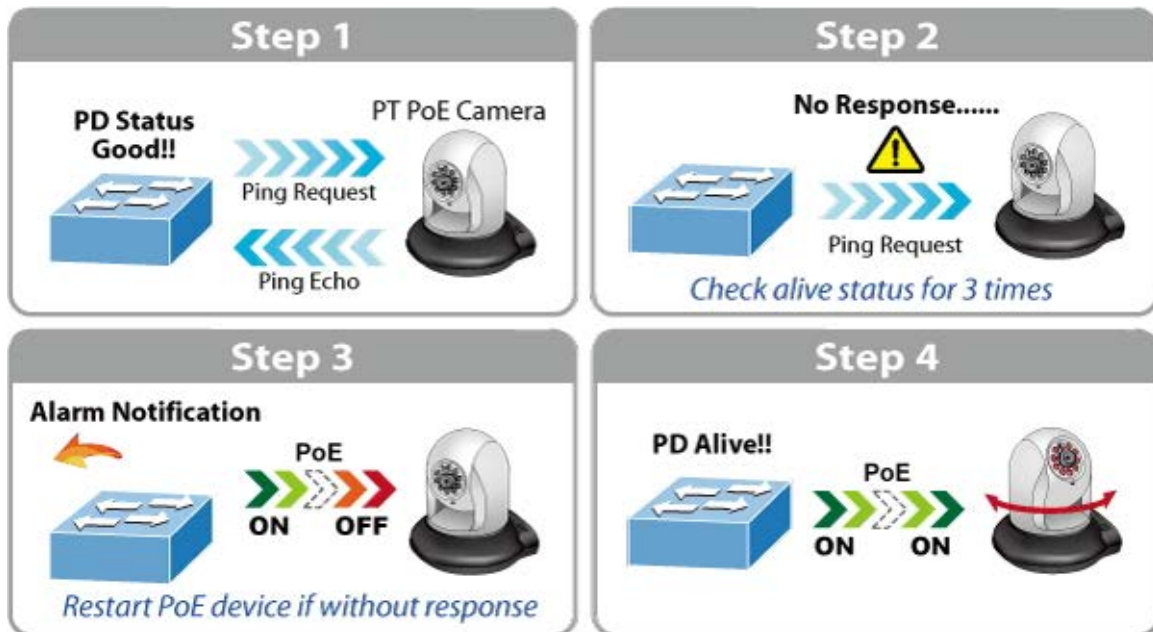


Object	Description
<b>Start Min</b>	Allows user to set what minute PoE function does by enabling it.
<b>End Hour</b>	Allows user to set what hour PoE function does by disabling it.
<b>End Min</b>	Allows user to set what minute PoE function does by disabling it.
<b>Reboot Enable</b>	Allows user to enable or disable the whole PoE port reboot by PoE reboot schedule. Please note that if you want PoE schedule and PoE reboot schedule to work at the same time, please use this function, and don't use <b>Reboot Only</b> function. This function offers administrator to reboot PoE device at an indicated time if administrator has this kind of requirement.
<b>Reboot Only</b>	Allows user to reboot PoE function by PoE reboot schedule. Please note that if administrator enables this function, PoE schedule will not set time to profile. This function is just for PoE port to reset at an indicated time.
<b>Reboot Hour</b>	Allows user to set what hour PoE reboots. This function is only for PoE reboot schedule.
 button	Click to add new rule.
 button	Click to apply changes.
 button	Check to delete the entry.

**Table 4-6-4:** Descriptions of the PoE Schedule Configuration Objects

### 4.6.4 PoE Alive Check Configuration

The Renewable Energy Switch can be configured to monitor connected PD's status in real-time via ping action. Once the PD stops working and without response, the Renewable Energy Switch are going to restart PoE port power, and bring the PD back to work. It will greatly enhance the reliability and reduces administrator management burden.




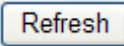
This page provides you with how to configure PD Alive Check as the screen in Figure 4-6-6 appears.

Port	Mode	Remote PD IP Address	Interval Time (10~300s)	Retry Count (1~5)	Action	Reboot Time (30~180s)
1	Disable ▾	192.168.0.101	60	2 ▾	None ▾	60
2	Disable ▾	192.168.0.101	60	2 ▾	None ▾	60
3	Disable ▾	192.168.0.101	60	2 ▾	None ▾	60
4	Disable ▾	192.168.0.101	60	2 ▾	None ▾	60

Apply Refresh

Figure 4-6-6: PD Alive Check Configuration Web Page Screen

Object	Description
<b>Mode</b>	Allows user to enable or disable per port PD Alive Check function. All ports are disabled as default value.
<b>Remote PD IP Address</b>	This column allows user to set PoE device IP address here for system making ping to the PoE device. Please note that the PD's IP address must be set to the same network segment as the Renewable Energy Switch.
<b>Interval Time (10~300s)</b>	This column allows user to set how long system should issue a ping

Object	Description
	request to PD for detecting whether PD is alive or dead. Interval time range is from 10 seconds to 300 seconds.
<b>Retry Count (1~5)</b>	This column allows user to set how many times system wants to retry ping to PD. For example, if we set count 2, the meaning is that if system retry ping to the PD and the PD doesn't response continuously, the PoE port will be reset.
<b>Action</b>	<p>Allows user to set which action will be apply if the PD is without any response. The Renewable Energy Switch offers 3 actions as follows:</p> <p><b>PD Reboot:</b> It means system will reset the PoE port that is connected to the PD.</p> <p><b>PD Reboot &amp; Alarm:</b> It means system will reset the PoE port and issue an alarm message via Syslog,</p> <p><b>Alarm:</b> It means system will issue an alarm message via Syslog.</p>
<b>Reboot Time (30~180s)</b>	<p>This column allows user to set the PoE device rebooting time. As there are so many kinds of PoE devices on the market, they have different rebooting times.</p> <p>The PD Alive-check is not a defining standard, so the PoE device on the market doesn't report reboots done information to the Ultra PoE Managed Injector Hub. So user has to make sure how long the PD will be finished to boot, and then set the time value to this column.</p> <p>System is going to check the PD again according to the reboot time. If you cannot make sure precise booting time, we suggest you set it longer.</p>
 button	Click to apply changes.
 button	Refreshes the Web page and the current configuration if user doesn't save it.

**Table 4-6-5:** Descriptions of the PoE Schedule Configuration Objects

## 4.7 Maintenance

The page displays the following tabbed panes relative to system configurations as [Figure 4-7-1](#) is shown below:

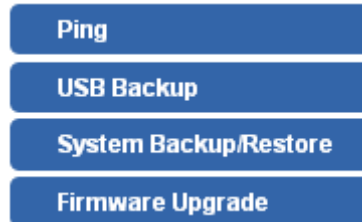


Figure 4-7-1: Maintenance Function Menu

The page includes the following information:

Object	Description
Ping	Allow you to issue ICMP PING packets to troubleshoot IP. <a href="#">Explained in section 4.7.1.</a>
USB Backup	Backup and restore setting file via USB HDD. <a href="#">Explained in section 4.7.2.</a>
System Backup/Restore	Backup and restore setting file via PC. <a href="#">Explained in section 4.7.3.</a>
Firmware	Firmware upgrade. <a href="#">Explained in section 4.7.4.</a>

## 4.7.1 Ping

This page allows you to issue ICMP PING packets to troubleshoot IP connectivity issues.


After you press “**Ping**”, 5 ICMP packets are transmitted, and the sequence number and roundtrip time are displayed upon reception of a reply. The page refreshes automatically until responses to all packets are received, or until a timeout occurs. The ICMP Ping screen in [Figure 4-7-2](#) appears. [Table 4-7-1](#) describes the ICMP Ping Objects Screen of Renewable Energy Switch.

**IP Address :**   
**Counts :**

**Figure 4-7-2:** ICMP Ping Web Page Screen

Object	Description
<b>IP Address</b>	The destination IP Address.
<b>Counts</b>	The time of ping.
<input type="button" value="Refresh"/> button	Press this button to refresh the current Web page.

**Table 4-7-1:** Descriptions of the ICMP Ping Configuration Objects



Be sure the target IP address is within the same network subnet of the Renewable Energy Switch, or you have to set up the correct gateway IP address.

## 4.7.2 USB Backup

This page shows the status of the USB HDD. You may save the setting file to USB HDD and load the setting file from USB HDD as the screen in [Figure 4-7-3](#) appears. [Table 4-7-2](#) describes the WAN Objects Screen of Renewable Energy Switch.

USB HDD : HDD Detected (Available Space: 7.881412GB)

Save Settings to USB HDD :

Load Settings from USB HDD :

*\*Please format the HDD to FAT32 on a Windows PC before using it for backup\**

Figure 4-7-3: USB Backup Web Page Screen

Object	Description
USB HDD	The status of USB HDD.
Save Settings to USB HDD	Press <input type="button" value="Save"/> button to save setting file to USB HDD.
Load Settings from USB HDD	Press <input type="button" value="Upload"/> button to upload setting file from USB HDD.
<input type="button" value="Refresh"/> button	Press this button to refresh the current Web page.

Table 4-7-2: Descriptions of the USB Backup Configuration Objects

## 4.7.3 System Backup/Restore

You may save the setting file to PC and load the setting file from PC as the screen in [Figure 4-7-4](#) appears. [Table 4-7-3](#) describes the System Backup/Restore Objects Screen of Renewable Energy Switch.

Save Settings to File :

Load Settings from File :  No file chosen

Reset Settings to Default :

*Note:  
Press the "Reset" button will be disconnected from system and reset all configuration to factory default.  
The default IP address is 192.168.0.100 and subnet mask is 255.255.255.0.*

Figure 4-7-4: System Backup/Restore Web Page Screen

Object	Description
Save Settings to File	Press <input type="button" value="Save"/> button to save setting file to PC.

Object	Description
Load Settings from File	Press <input type="button" value="Choose File"/> button to select the setting file, then press <input type="button" value="Upload"/> button to upload setting file from PC.
Reset Setting to Default	Press <input type="button" value="Reset"/> button to reset to factory default.

Table 4-7-3: Descriptions of the System Backup/Restore Objects

#### 4.7.4 Firmware Upgrade

This section provides the firmware upgrade of Renewable Energy Switch as the screen in [Figure 4-7-5](#) appears.

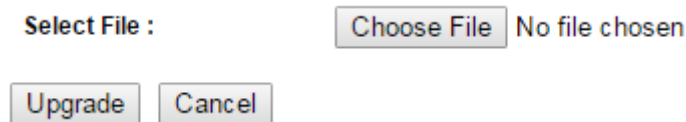


Figure 4-7-5: Firmware Upgrade Web Page Screen

Object	Description
<input type="button" value="Choose File"/> button	Press the button to select the firmware.
<input type="button" value="Upgrade"/> button	Press the button upgrades firmware to system.

Table 4-7-4: Descriptions of the Firmware Upgrade Objects

## 5. POWER OVER ETHERNET OVERVIEW

### What is PoE?

Based on the global standard IEEE 802.3af, PoE is a technology for wired Ethernet, the most widely installed local area network technology adopted today. PoE allows the electrical power necessary for the operation of each end-device to be carried by data cables rather than by separate power cords. New network applications, such as IP Cameras, VoIP Phones, and Wireless Networking, can help enterprises improve productivity. It minimizes wires that must be used to install the network for offering lower cost, and less power failures.

IEEE802.3af, also called Data Terminal equipment (DTE) power via Media dependent interface (MDI), is an international standard to define the transmission for power over Ethernet. The IEEE 802.3af also defines two types of source equipment: Mid-Span and End-Span.

#### ■ Mid-Span

Mid-Span device is placed between legacy switch and the powered device. Mid-Span taps the unused wire pairs 4/5 and 7/8 to carry power; the other four are for data transmission

#### ■ End-Span

End-Span device is directly connected with power device. End-Span could also tap the wire 1/2 and 3/6.

#### ■ PoE system architecture

The specification of PoE typically requires two devices: the Powered Source Equipment (PSE) and the Powered Device (PD). The PSE is either an End-Span or a Mid-Span, while the PD is a PoE-enabled terminal, such as IP Phones, Wireless LAN, etc. Power can be delivered over data pairs or spare pairs of standard CAT-5e cabling.

#### ■ How power is transferred through the cable

A standard Cat5e Ethernet cable has four twisted pairs, but only two of these are used for 10BASE-T, 100BASE-TX and 1000BASE-T. The specification allows two options for using these cables for power as shown in [Figure 5-1-1](#) and [Figure 5-1-2](#).

The spare pairs are used. [Figure 5-1-1](#) shows the pair on pins 4 and 5 are connected together and form the positive supply, and the pair on pins 7 and 8 is connected and forms the negative supply. (In fact, a late change to the spec allows either polarity to be used).



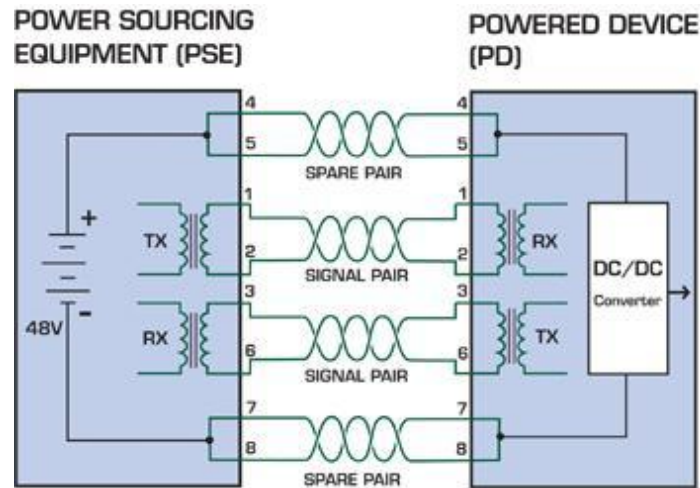


Figure 5-1-1 - Power Supplied over the Spare Pins

The data pairs are used. Since Ethernet pairs are transformer coupled at each end, it is possible to apply DC power to the center tap of the isolation transformer without upsetting the data transfer. In this mode of operation the pair on pins 3 and 6 and the pair on pins 1 and 2 can be of either polarity.

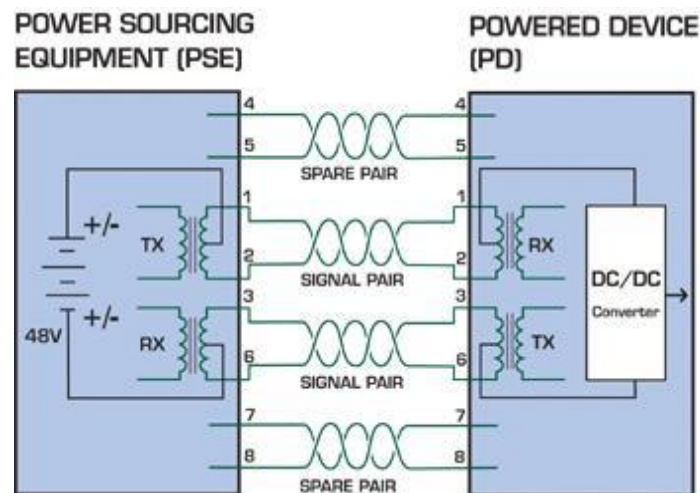


Figure 5-1-2 - Power Supplied over the Data Pins

### When to install PoE?

Consider the following scenarios:

- You're planning to install the latest VoIP Phone system to minimize cabling building costs when your company moves into new office next month.
- The company staff has been clamoring for a wireless access point in the picnic area behind the building so they can work on their laptops through lunch, but the cost of electrical power to the outside is not affordable.
- Management asks for IP Surveillance Cameras and business access systems throughout the facility, but they would rather avoid another electrician's payment.

## 6. THE POE PROVISION PROCESS

While adding PoE support to networked devices is relatively painless, it should be realized that power cannot simply be transferred over existing Cat5e cables. Without proper preparation, doing so may result in damage to devices that are not designed to support provision of power over their network interfaces.

The PSE is the manager of the PoE process. At the beginning, only small voltage level is induced on the port's output till a valid PD is detected during the Detection period. The PSE may choose to perform classification to estimate the amount of power to be consumed by this PD. After a time-controlled start-up, the PSE begins supplying the 52V DC level to the PD till it is physically or electrically disconnected. Upon disconnection, voltage and power shut down.

Since the PSE is responsible for the PoE process timing, it is the one generating the probing signals prior to operating the PD and monitoring the various scenarios that may occur during operation.

All probing is done using voltage induction and current measurement in return.

Stages of powering up a PoE link

Stage	Action	Volts specified		Volts managed by chipset
		802.3af	802.3at	
<b>Detection</b>	Measure whether powered device has the correct signature resistance of 15–33 kΩ	2.7-10.0		1.8–10.0
<b>Classification</b>	Measure which power level class the resistor indicates	14.5-20.5		12.5–25.5
<b>Startup</b>	Where the powered device will start up	>42	>37.2	>38
<b>Normal operation</b>	Supply power to device	44-57	50-57	25.0–60.0

### 6.1 Line Detection

Before power is applied, safety dictates that it must first be ensured that a valid PD is connected to the PSE's output. This process is referred to as "line detection", and involves the PSE seeking a specific, 25 KΩ signature resistor. Detection of this signature indicates that a valid PD is connected, and that provision of power to the device may commence.

The signature resistor lies in the PD's PoE front-end, isolated from the rest of the PD's circuitries till detection is certified.

---

## 6.2 Classification

Once a PD is detected, the PSE may optionally perform classification, to determine the maximal power a PD is to consume. The PSE induces 15.5-25.5V DC, limited to 600 mA, for a period of 10 to 75 ms responded by a certain current consumption by the PD, indicating its power class.

The PD is assigned to one of 5 classes: 0 (default class) indicates that full 15.4 watts should be provided, 1-3 indicate various required power levels and 4 is instead of reserved has a power range of 12.95 – 25.5 watts. PDs that support classification are assigned to class 0. Special care must be employed in the definition of class thresholds, as classification may be affected by cable losses.

Classifying a PD according to its power consumption may assist a PoE system in optimizing its power distribution. Such a system typically suffers from lack of power resources, so that efficient power management based on classification results may reduce total system costs.

## 6.3 Start-up

Once line detection and optional classification stages are completed, the PSE must switch from low voltage to its full voltage capacity (44-57 Volts) over a minimal amount of time (above 15 microseconds).

A gradual startup is required, as a sudden rise in voltage (reaching high frequencies) would introduce noise on the data lines.

Once provision of power is initiated, it is common for inrush current to be experienced at the PSE port, due to the PD's input capacitance. A PD must be designed to cease inrush current consumption (of over 350 mA / 600mA) within 50 ms of power provision startup.

## 6.4 Operation

During normal operation, the PSE provides 44-57 VDC, able to support a minimum of 15.4watt / 25.5-watt power.

### Power Overloads

The IEEE 802.3af / IEEE 802.3at standard defines handling of overload conditions. In the event of an overload (a PD drawing a higher power level than the allowed 12.95 watts / 25.5 watts), or an outright short circuit caused by a failure in cabling or in the PD, the PSE must shut down power within 50 to 75 milliseconds, while limiting current drain during this period to protect the cabling infrastructure. Immediate voltage drop is avoided to prevent shutdown due to random fluctuations.

## 6.5 Power Disconnection Scenarios

The IEEE 802.3af / IEEE 802.3at standard requires that devices powered over Ethernet be disconnected safely (i.e. power needs to be shut down within a short period of time following disconnection of a PD from an active port).

When a PD is disconnected, there is a danger that it will be replaced by a non-PoE-ready device while power is still on. Imagine disconnecting a powered IP phone utilizing 52 VDC, and then inadvertently plugging the powered Ethernet cable into a non-PoE notebook computer. What's sure to follow is not a pretty picture.

The standard defines two means of disconnection, DC Disconnect and AC Disconnect, both of which provide the same functionality - the PSE shuts down power to a disconnected port within 300 to 400ms. The upper boundary is a physical human limit for disconnecting one PD and reconnecting another.

### **DC Disconnect**

DC Disconnect detection involves measurement of current. Naturally, a disconnected PD stops consuming current, which can be inspected by the PSE. The PSE must therefore disconnect power within 300 to 400 ms from the current flow stop. The lower time boundary is important to prevent shutdown due to random fluctuations.

### **AC Disconnect**

This method is based on the fact that when a valid PD is connected to a port, the AC impedance measured on its terminals is significantly lower than in the case of an open port (disconnected PD).

AC Disconnect detection involves the induction of low AC signal in addition to the 52 VDC operating voltage. The returned AC signal amplitude is monitored by the PSE at the port terminals. During normal operation, the PD's relatively low impedance lowers the returned AC signal while a sudden disconnection of this PD will cause a surge to the full AC signal level and will indicate PD disconnection.

## APPENDIX A.

### A.1 MDI Settings

The Medium-Dependent Interface (MDI or RJ45) serves as the data/power interface between Ethernet elements. As such, it has two optional connection methods to carry the power. Named Alternative A & B, Table 1 details the two power feeding alternatives.

Pin	Alternative A	Alternative B
1	Vport Negative	
2	Vport Negative	
3	Vport Positive	
4		Vport Positive
5		Vport Positive
6	Vport Positive	
7		Vport Negative
8		Vport Negative

Table -1 Alternative Table

Delivering power through an RJ45 connector's center tap ("Phantom Feeding") guarantees that bi-directional data flow is maintained, regardless of a module's power status.

### A.2 Power Device Classification Values

Class	PD Current – Classification Period [mA]	PD Power – Operation Period [W]	Note
0	0 – 4	0.44 – 12.95	Default
1	9 – 12	0.44 – 3.84	Optional
2	17 -20	3.84 – 6.49	Optional
3	26 – 30	6.49 – 12.95	Optional
4	36 - 44	12.95 - 25	Optional

### A.3 DATA OUT PoE Injector RJ45 Port Pin Assignments

PIN NO	10BASE-T 100BASE-TX		1000BASE-T	
	1	TX+	DC-	DA+
2	TX-	DC-	DA-	DC-
3	RX+	DC+	DB+	DC+
4	-	DC+	DC+	DC+
5	-	DC+	DC-	DC+
6	RX-	DC+	DB-	DC+
7	-	DC-	DD+	DC-
8	-	DC0	DD-	DC0

### A.4 RJ45 Pin Assignment of Non-802.3af/802.3at Standard PD with PoE Mid-span PD

Pin out of Cisco non-802.3af standard Pin out of POE Mid-span  
PD

PIN NO	SIGNAL
1	RX+
2	RX-
3	TX+
4	VCC-
5	VCC-
6	TX-
7	VCC+
8	VCC+

PIN NO	SIGNAL
1	RX+
2	RX-
3	TX+
4	VCC-
5	VCC-
6	TX-
7	VCC+
8	VCC+

Before you power PD, please check whether the RJ45 connector pin assignment follows IEEE 802.3af/IEEE 802.3at standard; otherwise, you may need to change one of the RJ45 connector pin assignments, which is attached with the UTP cable.

## APPENDIX B.

### B.1 Recommended Use of the Connected Wires

(Applicable to the system with voltage attenuation less than 3%) The following table is applicable to the applications in the system.

Distance in feet ( meters )						
Amps	24 AWG	22 AWG	20 AWG	18 AWG	16 AWG	14 AWG
2.5	5.6 ft (1.95m)	8.8 ft (2.70m)	14.12 ft (4.30m)	22.50 ft (6.86m)	36.0 ft (11.0m)	56.4 ft (17.22m)
5.0	2.80 ft (0.86m)	4.4 ft (1.36m)	7.06 ft (2.16m)	11.26 ft (3.42m)	18.0 ft (5.48m)	28.2 ft (8.6m)
7.5	1.86 ft (0.56m)	2.96 ft (0.90m)	4.70 ft (1.44m)	7.50 ft (2.28m)	12.0 ft (3.66m)	18.82 ft (5.74m)
10	1.40 ft (0.42m)	2.22ft (0.68m)	3.52 ft (1.08m)	5.62 ft (1.72m)	9.0 ft (2.74m)	14.12 ft (4.30m)
12.5	1.12 ft (0.34m)	1.78ft (0.54m)	2.82 ft (0.86m)	4.50 ft (1.38m)	7.20 ft (2.20m)	11.30 ft (3.44m)
15	0.94 ft (0.28m)	1.48 ft (0.46m)	2.36 ft (0.72m)	3.76 ft (1.14m)	6.0 ft (1.82m)	9.42 ft (2.86m)

### B.2 Recommended Settings for Different Batteries

We suggest Nickel-cadmium battery and Lead-acid battery for BSP-360. You could set the Battery type at Battery Management on the web.

Description	Specifications
<b>Battery type</b>	<b>Nickel-cadmium Battery</b>
System voltage	<b>24V</b>
Maximum input voltage	45V DC
Output voltage for load	Equal to battery's voltage
Float charge voltage	27.2V DC (26.0~30.0V)
Absorption charge voltage	29.2V DC (28.0~32.0V)

Description	Specifications
LVD (Low Voltage Disconnection)	22.2V DC (21.0~25.0V)
LVR (Low Voltage Reconnection)	24.8V DC (23.0~27.0V)
Temperature compensation Baseline@25°C	±40 mV/°C for NiCad type batteries, Charge cut-off @ 55°C
<b>Battery type</b>	<b>Lead-acid Battery (Default Setting)</b>
System voltage	<b>24V</b>
Maximum input voltage	45V DC
Output voltage for load	Equal to battery's voltage
Float charge voltage	27.2V DC (26.0~30.0V)
Absorption charge voltage	29.2V DC (28.0~32.0V)
LVD (Low Voltage Disconnection)	22.2V DC (21.0~25.0V)
LVR (Low Voltage Reconnection)	24.8V DC (23.0~27.0V)
Temperature compensation Baseline@25°C	±60 mV/°C for lead acid type batteries, Charge cut-off @ 55°C