

LINOVISION

IOT-R32W

User Manual

Updated on January 01, 2024

Introduction

IOT-R32W is an Industrial Cellular Router that combines a 4G LTE and 4G DTU. Integrating an embedded cellular modem and dual SIM function, it provides a 3G/4G cellular network. It is also equipped with 2 fast Ethernet ports, 1 RS232 interface (RS485 optional), and supports Wi-Fi access. Features with compact and rugged design can be used as a reliable failover connection or wireless communication in harsh environments. It is suitable for various M2M/IoT applications, such as retail markets, vending machines, ATM machines, gas stations, etc.

Package Contents

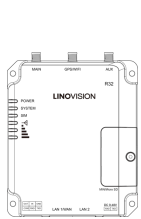

x1

IOT-R32W



x1

Ethernet Cable

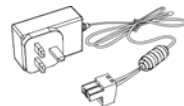

x1

Power Adapter



x3

Magnetic Cellular Antennas



x1

6-Pin Pluggable Terminal

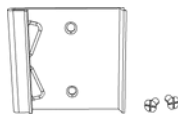

x1

DIN Rail Kit

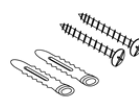

x1

Setscrews

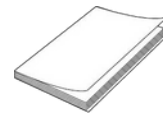

x1

User Manual

Hardware Introduction

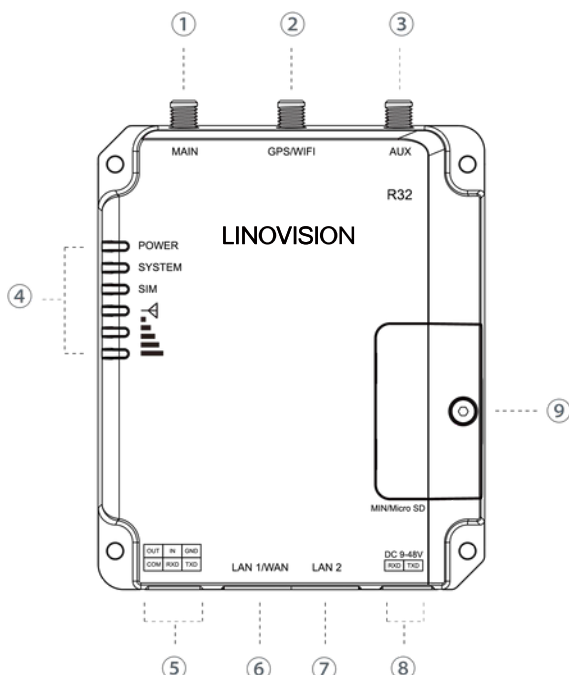

- ① MAIN: Cellular Antenna Connector
- ② GPS/WIFI: Antenna Connector
- ③ AUX: Cellular Antenna
- ④ LED Indicator Area
POWER: Power Indicator
SYSTEM: Status Indicator
SIM: Status Indicator
▽: Signal Strength Indicator
- ⑤ Serial Port & I/O
- ⑥ Ethernet LAN1/WAN Port
- ⑦ Ethernet LAN2 Port
- ⑧ Power Connector
- ⑨ SIM and Reset Button Holder

Indication

LED Indicator

LED	Indication	Status	Description		
POWER	Power Status	Off	The power is switched off.		
		On	The power is switched on.		
SYSTEM	System Status	Green Light	Static: Start-up		
			Blinking slowly: The system is running properly.		
		Red Light	The system goes wrong.		
SIM	SIM Card Status	Off	SIM1 or SIM2 is registering or fails to register (or there are no SIM cards inserted).		
		Green Light	Blinking slowly: SIM1 has been registered and is ready for dial-up.		
			Blinking rapidly: SIM1 has been registered and is dialing up now.		
			Static: SIM1 has been registered and dialed up successfully.		
		Orange Light	Blinking slowly: SIM2 has been registered and is ready for dial-up.		
			Blinking rapidly: SIM2 has been registered and is dialing up now.		
			Static: SIM2 has been registered and dialed up successfully.		
		Signal Strength	Signal 1/2/3	Off	No signal
				Green Light	Static/Off/Off: weak signals with 1-10 ASU (please check if the antenna is installed correctly, or move the antenna to a suitable location to get better signal)
Static/Static/Off: normal signals with 11-20 ASU (average signal strength)					
Static/Static/Static: strong signals with 21-31 ASU (signal is good)					

Reset The Router

Reset button is under the SIM slots.

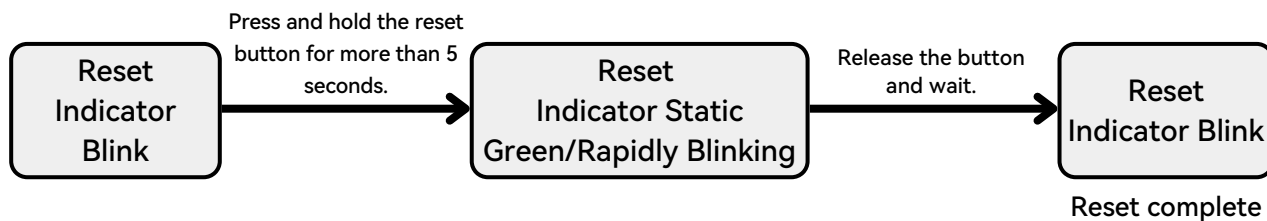

Installation

1 SIM Card/Micro SD Card Installation

A. Unscrew the cover of the SIM card then screw it up.



B. Put SIM card/Micro SD into the slot and take it off.

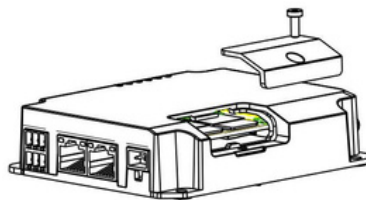

2 Antenna Installation

Rotate the antenna into the antenna connector accordingly.
The external antenna should be installed vertically always on a site with a good signal.

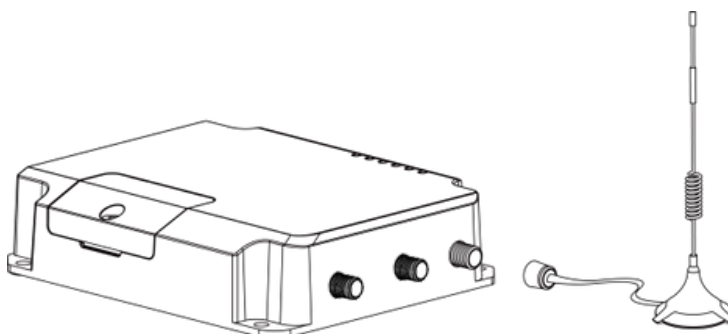

3 Serial Port Installation

Connect the Serial port as needed. Connection details are as follows.

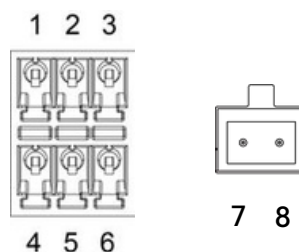

PIN	RS232	RS485	DI	DO	Description
1	/	/	/	OUT	Digital Output
2	/	/	IN	/	Digital Input
3	GND	/	/	/	Ground
4	/	/	COM	COM	Common Ground
5	RXD	B	/	/	Receive Data
6	TXD	A	/	/	Transmit Data
7	/	/	/	/	Positive
8	/	/	/	/	Negative

Log in the Web GUI of Router

1 PC Configuration

Please connect PC to LAN port of IOT-R32. PC can obtain an IP address, or you can configure a static IP address manually. The following steps are based on Windows 10 operating system for your reference.

Note: As remote access is disabled by default, you can't access to the router's Web GUI if you connect PC to WAN port of the router. But it will function properly if you enable it on Web GUI.

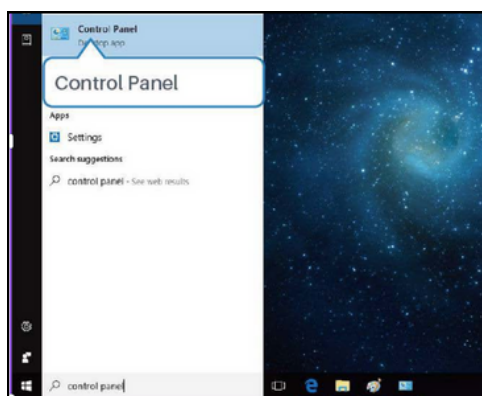

① Search “Control Panel” on the taskbar and click.

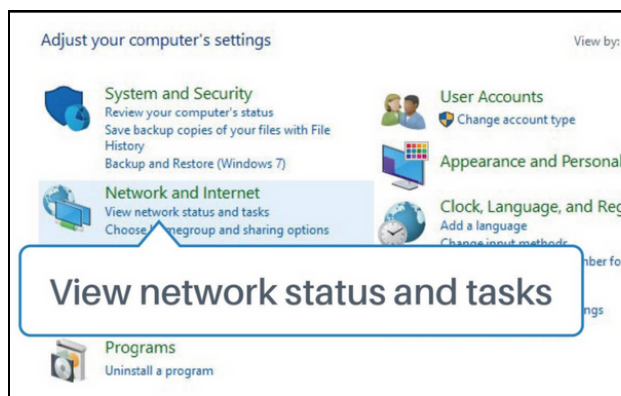

② Click “View network status and tasks”.

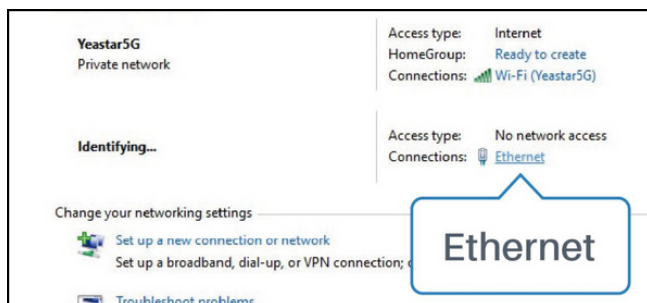

③ Click “Ethernet” (May have different names).

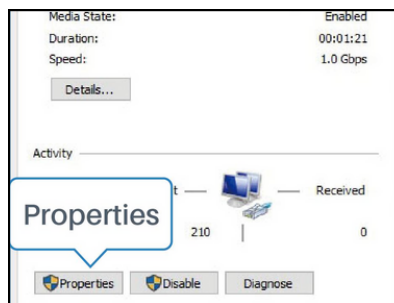

④ Click “Properties”.

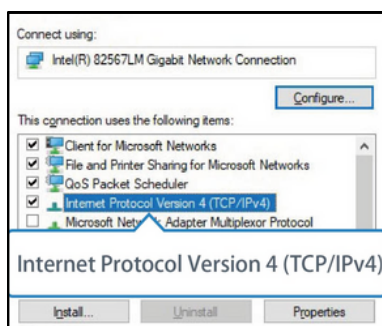

⑤ Double Click “Internet Protocol Version 4 (TCP/IPv4)” to configure IP address and DNS server.

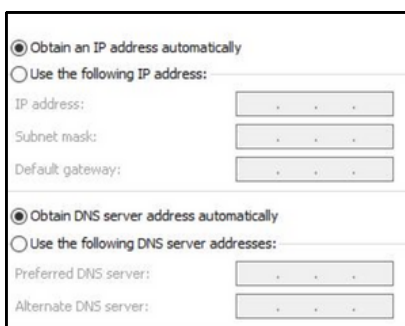

⑥ Method 1: Click “Obtain an IP address automatically”;

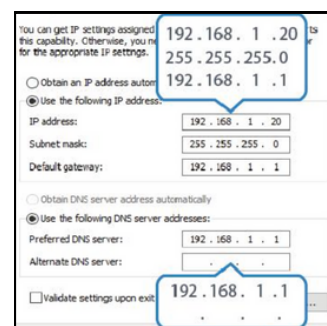

Method 2: Click “Use the following IP address” and fill in the information above.

*Remember to click “OK” to finish configuration.

2 Log in the Router

If this is the first time you configure the router, please use the default settings below:

IP Address: 192.168.1.1

Username: admin

Password: password

A. Start a Web browser on your PC (Chrome is recommended), type in the IP address, and press Enter on your keyboard.

B. Enter the username and password, click “Login”.

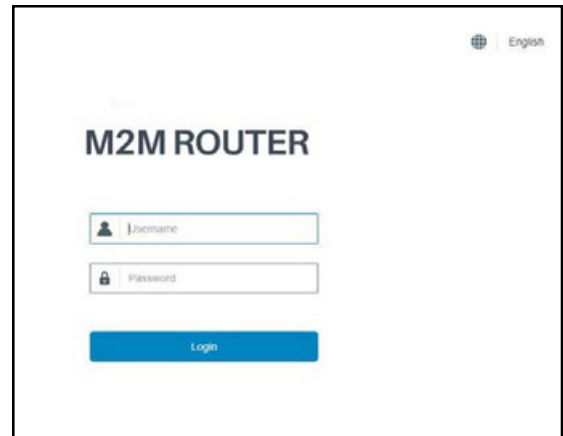

 If you enter the username or password incorrectly more than 5 times, the login page will be locked for 10 minutes.

Network Configuration

This chapter explains how to connect IOT-R32 to network via WAN connection or cellular.

1 Ethernet WAN Configuration

A. Go to “Network > Interface > Port” to change LAN1 to WAN port.

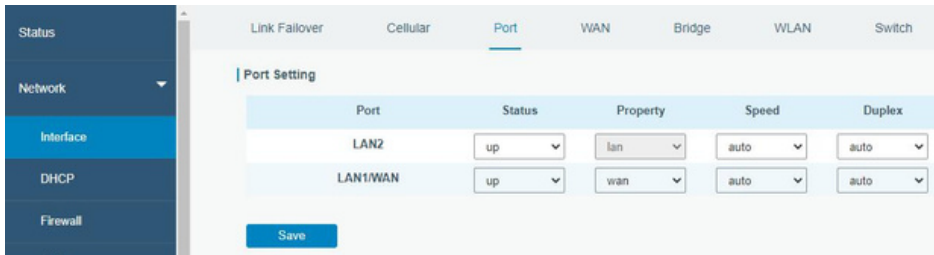

B. Go to “Network > Interface > WAN” to configure WAN parameters. Take static IP configuration as an example. DHCP client and PPPoE type are optional according to your requirements.

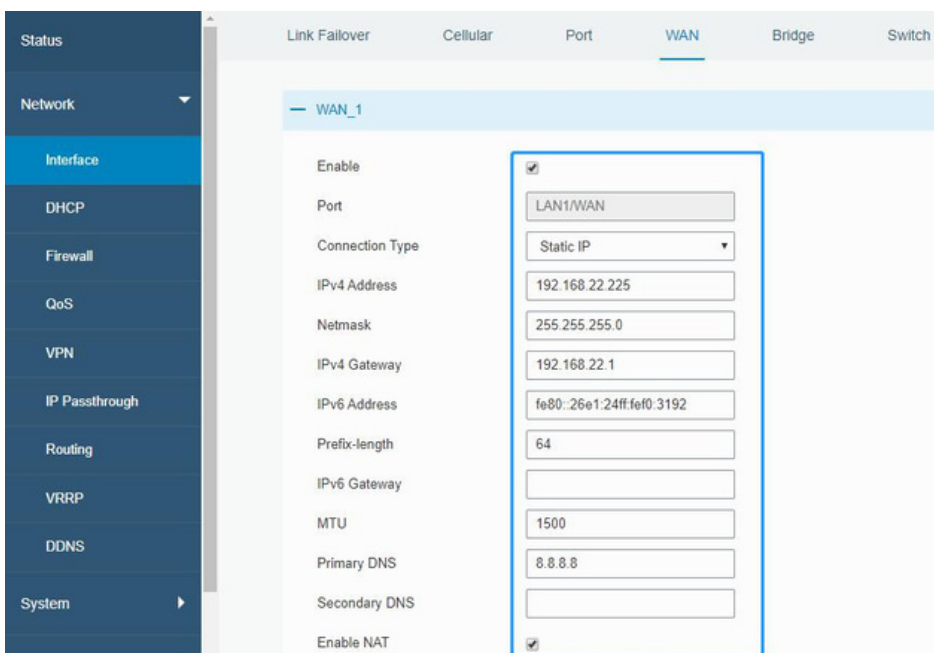

Click “Save & Apply” button to make the changes take effect.

C. Connect WAN port to another router or modem.

D. Log in IOT-R32 web GUI via WAN port IP address and go to “Status > Network” to check if status is “up”.



E. Go to “Network > Interface > Link Failover” to rise the WAN priority to 1.

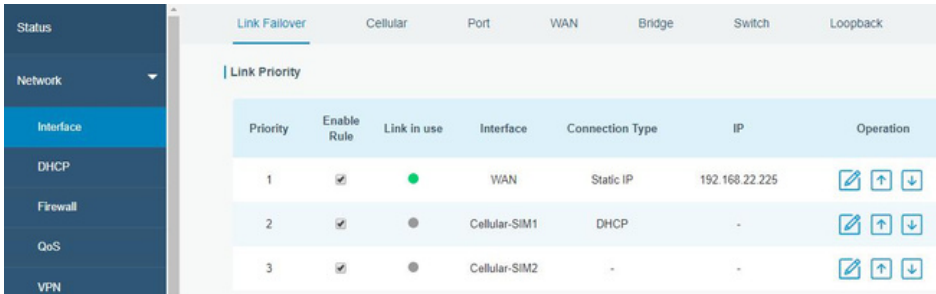

F. Open your preferred browser on PC, then type any available web address into address bar and see if it is able to visit Internet via IOT-R32 router.

2 Cellular Connection Configuration

Take inserting SIM card into SIM1 slot as an example; please refer to the following detailed operations.

A. Click “Network > Interface > Cellular > Cellular Setting” to configure the cellular info, like APN and network type.

B. Click “Save” and “Apply” for configuration to take effect.

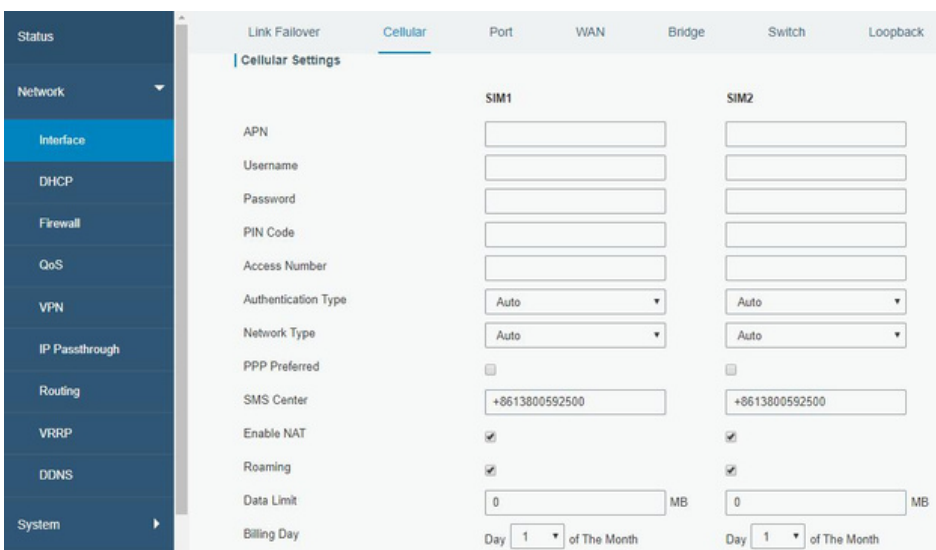

If you select “Auto”, the router will obtain ISP information from SIM card to set APN, Username, and Password automatically. This option will only be taken effect when the SIM card is issued from a well-known ISP.

C. Go to “Network > Interface > Link Failover” to enable SIM1 and rise link priority of SIM1.

Priority	Enable Rule	Link in use	Interface	Connection Type	IP	Operation
1	<input checked="" type="checkbox"/>	●	Cellular-SIM1	-	-	✎ ↑ ↓
2	<input checked="" type="checkbox"/>	●	Cellular-SIM2	DHCP	-	✎ ↑ ↓
3	<input checked="" type="checkbox"/>	●	WAN	Static IP	192.168.22.225	✎ ↑ ↓

D. Click  to configure ICMP ping detection information.

Ping Detection ✕

Enable

Primary Server (IPv4)

Secondary Server (IPv4)

Interval s

Retry Interval s

Timeout s

Max Ping Retries

E. Click “Status > Cellular” to view the status of the cellular connection. If it shows “Connected”, it means SIM1 has dialed up successfully.

On the other hand, you can check the status of SIM indicator. If it keeps on green light statically, it means SIM1 has dialed up successfully.

F. Open your preferred browser on PC, then type any available web address into address bar and see if it is able to visit Internet via IOT-R32 router.

More Information

For more information, please scan the QR code below



Specification Information



Advanced Settings